



OWNER'S MANUAL

MODELS

AB-TS09DT-230VI

AB-TS12DT-230VI

AB-TS18DT-230VI



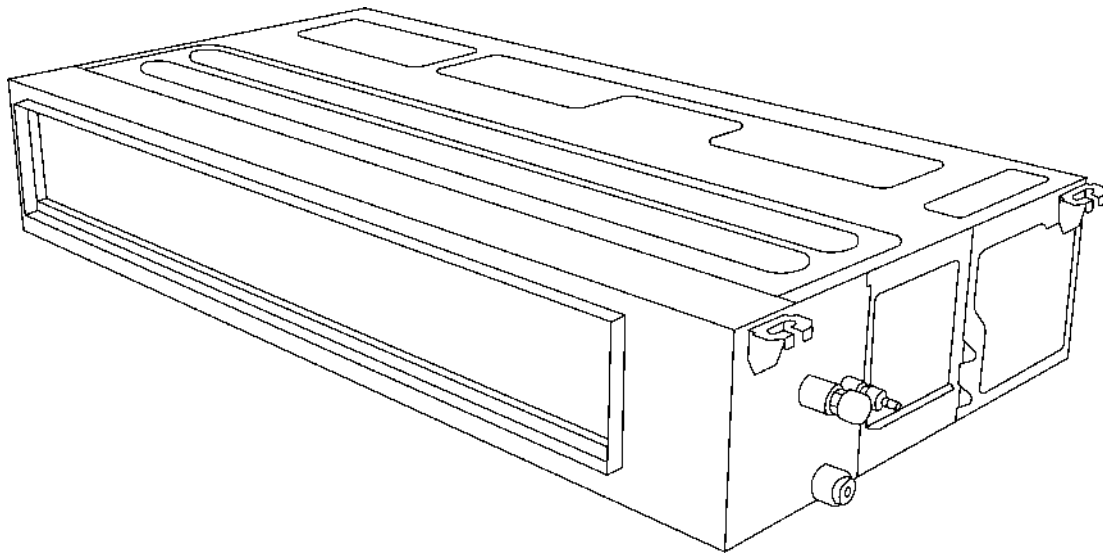

AB-TS24DT-230VI

SINGLE-ZONE SLIM DUCT



Please read this manual carefully and thoroughly before installing the unit.
Take care of this manual for future reference.

Safety Notice

 A2L  A2L	Caution: Risk of fire. The air conditioner is charged with inflammable refrigerant R32.
	Before using the air conditioner, please read the instruction manual first.
	Before installing the air conditioner, please read the instruction manual first.
	Before repairing the air conditioner, please read the technical service manual first.

Compared with common refrigerant, R32 is an environmental-friendly refrigerant that has no harm to the ozone layer and weak greenhouse effect. Its GWP is 675. Because of its thermodynamic characteristics, R32 requires a smaller charging quantity to reach high energy efficiency. It is inflammable and odourless, but may cause explosion under certain circumstances.

CONTENTS

Precautions	1
Instruction for Servicing (R32)	4
Refrigerant Sensor (Optional)	16
Parts and Functions	17
Indoor Unit Installation	20
Drainage Pipe Connection	25
Installation of the Duct	31
Outdoor Unit Installation	34
Refrigerant Pipes Installation	38
Electric Wiring	43
Test Run	46
Checks Before Operation	46
Maintenance	47
Important Safety Information	56
Troubleshooting	57
Disposal Guideline	59

Precautions

SAFETY RULES AND RECOMMENDATIONS FOR THE INSTALLER

1. **R**ead this guide before installing and using the appliance.
2. **D**uring the installation of the indoor and outdoor units, access to the working area should be forbidden to children. Unforeseeable accidents could happen.
3. **M**ake sure that the base of the outdoor unit is firmly fixed.
4. **C**heck that air cannot enter the refrigerant system and check for refrigerant leaks before turn on the air conditioner.
5. **C**arry out a test cycle after installing the air conditioner and record the operating data.
6. **P**rotect the unit with a fuse of suitable capacity for the maximum input current or with another overload protection device.
7. **E**nsure that the mains voltage matches the voltage indicated on the nameplate. Keep the switch clean and ensure that the power cord terminals are correctly connected to the circuit. This prevents the risk of electric shock or fire caused by poor contact.
8. **T**he appliance must be equipped with devices capable of disconnection from the mains power supply, have a contact separation in all poles to provide full disconnection under "over voltage category III conditions", these devices must also be incorporated into the fixed wiring in accordance with the wiring rules.
9. **T**he air conditioner must be installed by professional or qualified persons. Do not try to install the conditioner alone, always contact specialized technical personnel.
10. **D**o not install the appliance at a distance of less than 50 cm from inflammable substances (alcohol etc.) Or from pressurized containers (e. g. spray cans).
11. **I**f the appliance is used in areas without the possibility of ventilation, precautions must be taken to prevent any leaks of refrigerant gas from remaining in the environment and creating a danger of fire.
12. **T**he packaging materials are recyclable and should be disposed of in the separate waste bins. Take the air conditioner at the end of its useful life to a special waste collection center for disposal.
13. **O**nly use the air conditioner as instructed in this booklet. These instructions are not intended to cover every possible condition and situation. As with any electrical household appliance, common sense and caution are therefore always recommended for installation, operation and maintenance.
14. **T**he appliance must be installed in accordance with applicable national regulations.
15. **B**efore accessing the terminals, all the power circuits must be disconnected from the power supply.

-
16. **T**his appliance can be used by children aged from 8 years and above and persons with reduced physical, sensory or mental capabilities or lack of experience and knowledge if they have been given supervision or instruction concerning use of the appliance in a safe way and understand the hazards involved. Children shall not play with the appliance. Cleaning and user maintenance shall not be made by children without supervision.
 17. **C**leaning and maintenance must be carried out by specialized technical personnel. In any case disconnect the appliance from the mains electricity supply before carrying out any cleaning or maintenance.
 18. **T**his appliance has been made for air conditioning domestic environments and must not be used for any other purpose, such as for drying clothes, cooling food, etc.
 19. **A**lways use the appliance with the air filter mounted. Air conditioning without air filter could cause an excessive accumulation of dust and/or lead inner parts function failure.
 20. **T**he user is responsible for having the appliance installed by a qualified technician, who must check that earthing/grounding is done in accordance with current legislation and insert a thermal-magnetic circuit breaker.
 21. **T**he batteries in the remote controller must be recycled or disposed of properly. For disposal of scrap batteries, please discard the batteries as sorted municipal waste at the accessible collection point.
 22. **N**ever remain directly exposed to the flow of cold air for a long time. The direct and prolonged exposure to cold air could be dangerous for your health. Particular care should be taken in the rooms where there are children, old or sick people.
 23. **I**f the appliance gives off smoke or there is a smell of burning, immediately cut off the power supply and contact the Service Center. The prolonged use of the device in such conditions could cause fire or electrocution.
 24. **H**ave repairs carried out only by an authorised Service Center of the manufacturer. Incorrect repair could expose the user to the risk of electric shock, etc.
 25. **U**nhook the switch if you foresee not to use the device for a long time. The airflow direction must be properly adjusted.
 26. **T**he flaps must be directed downwards in the heating mode and upwards in the cooling mode.
 27. **E**nsure that the appliance is disconnected from the power supply when it intends to keep inoperative for a long period and before carrying out any cleaning or maintenance.
 28. **S**electing the most suitable temperature can prevent damage to the appliance.

SAFETY RULES AND PROHIBITIONS

1. **D**o not bend, tug or compress the power cord since this could damage it. Electrical shocks or fire are probably due to a damaged power cord. Specialized technical personnel only is recommended to replace a damaged power cord.
2. **D**o not use extensions or gang modules.
3. **D**o not touch the appliance when barefoot or parts of the body are wet or damp.
4. **D**o not obstruct the air inlet or outlet of the indoor or the outdoor unit. The obstruction of these openings causes a reduction in the operative efficiency of the conditioner with possible consequent failures or damages.
5. **I**n no way alter the characteristics of the appliance.
6. **D**o not install the appliance in environments where the air could contain flammable gas, oil or sulphur or near sources of heat.
7. **T**his appliance is not intended for use by persons (including children) with reduced physical, sensory or mental capabilities, or lack of experience and knowledge, unless they have been given supervision or instruction concerning use of the appliance by a person responsible for their safety.
8. **D**o not climb onto or place any heavy or hot objects on top of the appliance.
9. **D**o not leave windows or doors open for long time when the air conditioner is operating.
10. **D**o not direct the airflow onto plant or animals.
11. **A**long direct exposition to the flow of cold air of the conditioner could have negative effects on plants and animals.
12. **D**o not put the conditioner in contact with water. The electrical insulation could be damaged and thus causing electrocution.
13. **D**o not climb onto or place any objects on the outdoor unit.
14. **N**ever insert a stick or similar object into the appliance. It could cause injury.
15. **C**hildren should be supervised to ensure that they do not play with the appliance.
16. **T**his unit is equipped with a refrigerant leak detector for safety.
17. **T**his refrigerant sensor is only replaced with a manufacturer approved sensor. If the sensor is replaced only as part of the component assembly, the component should be labeled.
(Some models have refrigerant leak sensors, subject to the actual product received.)
18. **T**he appliance shall be installed according to the manufacturer's instructions, and the ventilation pipe shall not exceed the maximum length and number of turns specified by the manufacturer .
19. **A**ppliances shall be installed according to the instructions. Appliances that can be installed in different locations should be tested in all locations permitted by the manufacturer. The intake or exhaust openings should not be covered and the manufacturer's recommended air filter should be installed according to the instructions.

NOTE(WiFi models only)

This device complies with Part 15 of the FCC Rules. Operation is subject to the following two conditions:

1. This device may not cause harmful interference.
2. This device must accept any interference received, including interference that may cause undesired operation.

Instruction for Servicing (R32)

1. Check the information in this manual to find out the dimensions of space needed for proper installation of the device, including the minimum distances allowed compared to adjacent structures.
2. Appliance shall be installed, operated and stored in a room with a floor area larger than 4 m².
3. The installation of pipe-work shall be kept to a minimum.
4. The pipe-work shall be protected from physical damage, and shall not be installed in an unventilated space if the space is smaller than 4m².
5. The compliance with national gas regulations shall be observed.
6. The mechanical connections shall be accessible for maintenance purposes.
7. Follow the instructions given in this manual for handling, installing, cleaning, maintaining and disposing of the refrigerant.
8. Make sure ventilation openings clear of obstruction.
9. **Notice:** The servicing shall be performed only as recommended by the manufacturer.
10. **Warning:** The appliance shall be stored in a well-ventilated area where the room size corresponds to the room area as specified for operation.
11. **Warning:** The appliance shall be stored in a room without continuously operating open flames (for example an operating gas appliance) and ignition sources (for example an operating electric heater).
12. The appliance shall be stored so as to prevent mechanical damage from occurring.
13. It is appropriate that anyone who is called upon to work on a refrigerant circuit should hold a valid and up-to-date certificate from an assessment authority accredited by the industry and recognizing their competence to handle refrigerants, in accordance with the assessment specification recognized in the industrial sector concerned. Service operations should only be carried out in accordance with the recommendations of the equipment manufacturer. Maintenance and repair operations that require the assistance of other qualified persons must be conducted under the supervision of the person competent for the use of flammable refrigerants.
14. Every working procedure that affects safety factors shall only be carried out by specialized persons.

15. Warning:

- * Do not use any means to accelerate the defrosting process or clean the frost on your own. Follow the recommended guidelines from the manufacturer.
- * The appliance shall be stored in a room without continuously operating ignition sources (for example: open flames, an operating gas appliance or an operating electric heater).
- * Do not pierce or burn.
- * Be aware that refrigerants may not contain an odor.

Important Considerations

1. The air conditioner must be installed by professional personnel and the Installation manual is used only for the professional installation personnel! The installation specifications should be subject to our after-sale service regulations.
2. When filling the combustible refrigerant, any of your rough operations may cause serious or injuries to human body and objects.
3. A leak test must be done after the installation completed.
4. It is a must to do the safety inspection before maintaining or repairing an air conditioner using combustible refrigerant in order to ensure that the fire risk is reduced to minimum.
5. It is necessary to operate the machine under a controlled procedure in order to ensure that any risk arising from the combustible gas or vapor during the operation is reduced to minimum.
6. Requirements for the total weight of filled refrigerant and the area of a room to be equipped with an air conditioner (are shown as in the following Tables GG.1 and GG.2)

Refrigerant Charge and Room Area Limitations

In UL/CSA 60335-2-40, R32 refrigerant is classified as class A2L, which is mildly flammable.

Therefore, R32 refrigerant is suitable for systems needing additional refrigerant charge and which will limit the area of the rooms being served by the system. Similarly, the total amount of refrigerant in the system shall be less than or equal to the allowable maximum refrigerant charge. The allowable maximum refrigerant charge depends on the area of the rooms being served by the system.

NOTE:

The nouns in this section are explained as follows:

Mc: The actual refrigerant charge in the system.

A: The actual room area where the appliance is installed.

Amin: The required minimum room area.

Mmax: The allowable maximum refrigerant charge in a room.

Qmin: The minimum circulation airflow .

Anvmin: The minimum opening area for connected rooms.

The maximum charge and the required minimum floor area

$m_1 = (6 \text{ m}^3) \times \text{LFL}$, $m_2 = (52 \text{ m}^3) \times \text{LFL}$, $m_3 = (260 \text{ m}^3) \times \text{LFL}$

Where LFL is the lower flammable limit in kg/ m^3 , R32 LFL is 0.306 kg/ m^3 .

The maximum charge in a room shall be in accordance with the following:

Table GG.1 - Maximum charge (kg)

Category	LFL (kg/m ³)	h ₀ (m)	Floor area (m ²)						
			4	7	10	15	20	30	50
R32	0.306	2.5	1.53	2.68	3.83	5.51	6.36	7.79	10.06
		2.8	1.71	3.00	4.28	6.17	7.12	8.73	11.27
		3	1.84	3.21	4.59	6.61	7.63	9.35	12.07

Table GG.1 - Maximum charge (oz)

Category	LFL (lbs/ft ²)	h ₀ (ft)	Floor area (m ²)						
			43.06 ft ²	75.35 ft ²	107.64 ft ²	161.46 ft ²	215.28 ft ²	322.92 ft ²	538.20 ft ²
R32	0.0191	8.2	3.37	5.91	8.44	12.15	14.02	17.17	22.18
		9.19	3.77	6.61	9.44	13.6	15.69	19.25	24.84
		9.84	4.06	7.07	10.12	14.58	16.82	20.62	26.61

For R32 refrigerant charge amount and minimum room area:

The machine you purchased may be one of the types in the table below. The indoor and outdoor units are designed to be used together. Please check the machine you purchased. The indoor unit should be installed at least 8.2ft /2.5m above from the floor, and the minimum room area of operating or storage should be as specified in the following table

Table GG.2 - Minimum room area (m²)

Category	LFL (kg/m ³)	h ₀ (m)	Charge amount (M) (kg) Minimum room area (m ²)						
			0.58	0.60	1.00	1.07	1.20	1.58	2.00
R32	0.306	2.5	1.52	1.57	2.61	2.80	3.14	4.13	5.23
		2.8	1.35	1.40	2.33	2.50	2.80	3.69	4.67
		3	1.26	1.31	2.18	2.33	2.61	3.44	4.36

Table GG.2 - Minimum room area (ft²)

Category	LFL (lbs/ft ²)	h ₀ (m)	Charge amount (M) (lbs) Minimum room area (ft ²)						
			0.58lbs	0.60lbs	1.00lbs	1.07lbs	1.20lbs	1.58lbs	2.00lbs
R32	0.0191	8.2	16.36	16.90	28.10	30.14	33.79	44.45	56.28
		9.19	14.53	15.07	25.08	26.91	30.14	39.72	50.27
		9.84	13.56	14.10	23.47	25.08	28.10	37.03	46.94



Caution: Risk of fire



A2L



Read operator's manual



Operating instructions



Caution: Risk of fire

A2L



Read technical manual

7. Information on servicing:

1) Checks to the area

Prior to beginning work on systems containing flammable refrigerants, safety checks are necessary to ensure that the risk of ignition is minimized. For repair to the refrigerating system, the following precautions shall be complied with prior to conducting work on the system.

2) Work procedure

Work shall be undertaken under a controlled procedure so as to minimize the risk of a flammable gas or vapor being present while the work is being performed.

3) General work area

All maintenance staff and others working in the local area shall be instructed on the nature of work being carried out. Work in confined spaces shall be avoided. The area around the workspace shall be sectioned off. Ensure that the conditions within the area have been made safe by control of flammable material.

4) Checking for presence of refrigerant

The area shall be checked with an appropriate refrigerant detector prior to and during work, to ensure the technician is aware of potential flammable atmospheres. Ensure that the leak detection equipment being used is suitable for use with flammable refrigerants, i.e. non-sparking, adequately sealed or intrinsically safe.

5) Presence of fire extinguisher

If any hot work is to be conducted on the refrigeration equipment or any associated parts, appropriate fire extinguishing equipment shall be available to hand. Have a dry powder or CO₂ fire extinguisher adjacent to the charging area.

6) No ignition sources

No person carrying out work in relation to a refrigeration system which involves exposing any pipe work shall use any sources of ignition in such a manner that it may lead to the risk of fire or explosion. All possible ignition sources, including cigarette smoking, should be kept sufficient far away from the site of installation, repairing, removing and disposal, during which refrigerant can possibly be released to the surrounding space. Prior to work taking place, the area around the equipment is to be surveyed to make sure that there are no flammable hazards or ignition risks. "No Smoking" signs shall be displayed.

7) Ventilated area

Ensure that the area is in the open or that it is adequately ventilated before breaking into the system or conducting any work that will produce heat. A degree of ventilation shall continue during the period that the work is carried out. The ventilation should safely disperse any released refrigerant and preferably expel it externally into the atmosphere.

8) Checks to the refrigeration equipment

Where electrical components are being changed, they shall be fit for the purpose and to the correct specification. At all times the manufacturer's maintenance and service guidelines shall be followed.

If in doubt consult the manufacturer's technical department for assistance.

The following checks shall be applied to installation using flammable refrigerant

- The charge size is in accordance with the room size within which the refrigerant containing parts are installed;
- The ventilation machinery and outlets are operating adequately and are not obstructed;
- If an indirect refrigerating circuit is being used, the secondary circuit shall be checked for the presence of refrigerant;
- Marking to the equipment continues to be visible and legible. Markings and signs that are illegible shall be corrected;
- Refrigeration pipe or components are installed in a position where they are unlikely to be exposed to any substance which may corrode refrigerant containing components, unless the components are constructed of materials which are inherently resistant to being corroded or are suitably protected against being so corroded.

9) Checks to electrical devices

Repair and maintenance to electrical components shall include initial safety checks and component inspection procedures. If a fault exists that could compromise safety, then no electrical supply shall be connected to the circuit until it is satisfactorily dealt with. If the fault cannot be corrected immediately but it is necessary to continue operation, an adequate temporary solution shall be used. This shall be reported to the owner of the equipment so all parties are advised.

Initial safety checks shall include:

- That capacitors are discharged: this shall be done in a safe manner to avoid possibility of sparking;
- That no live electrical components and wiring are exposed while charging, recovering or purging the system;
- That there is continuity of earth bonding.

8. Repairs to sealed components

Sealed electrical components shall be replaced.

9. Repair to intrinsically safe components

Intrinsically safe components must be replaced.

10. Cabling

Check that cabling will not be subject to wear, corrosion, excessive pressure, vibration, sharp edges or any other adverse environmental effects. The check shall also take into account the effects of aging or continual vibration from sources such as compressors or fans.

11. Detection of flammable refrigerant

Under no circumstances shall potential sources of ignition be used in the searching for or detection of refrigerant leaks. A halide torch (or any other detector using a naked flame) shall not be used.

12. Leak detection methods

The following leak detection methods are deemed acceptable for systems containing flammable refrigerants.

Electronic leak detectors shall be used to detect flammable refrigerants, but the sensitivity may not be adequate, or may need re-calibration. (Detection equipment shall be calibrated in a refrigerant-free area.) Ensure that the detector is not a potential source of ignition and is suitable for the refrigerant used. Leak detection equipment shall be set at a percentage of the LFL of the refrigerant and shall be calibrated to the refrigerant employed and the appropriate percentage of gas (25 % maximum) is confirmed. Leak detection fluids are suitable for use with most refrigerants but the use of detergents containing chlorine shall be avoided as the chlorine may react with the refrigerant and corrode the copper pipe-work. If a leak is suspected, all naked flames shall be removed/ extinguished. If a leakage of refrigerant is found which requires brazing, all of the refrigerant shall be recovered from the system, or isolated (by means of shut off valves) in a part of the system remote from the leak. Oxygen free nitrogen (OFN) shall then be purged through the system both before and during the brazing process.

13. Removal and evacuation

When breaking into the refrigerant circuit to make repairs or for any other purpose conventional procedures shall be used. However, it is important that best practice is followed since inflammability is a consideration. The following procedure shall be adhered to:

- Remove refrigerant;

-
- Purge the circuit with inert gas;
 - Evacuate;
 - Purge again with inert gas;
 - Open the circuit by cutting or brazing.

The refrigerant charge shall be recovered into the correct recovery cylinders. The system shall be flushed with OFN to render the unit safe. This process may need to be repeated several times.

Compressed air or oxygen shall not be used for this task.

Flushing shall be achieved by breaking the vacuum in the system with OFN and continuing to fill until the working pressure is achieved, then venting to atmosphere, and finally pulling down to a vacuum. This process shall be repeated until no refrigerant is within the system. When the final OFN charge is used, the system shall be vented down to atmospheric pressure to enable work to take place. This operation is absolutely vital if brazing operations on the pipe-work are to take place.

Ensure that the outlet for the vacuum pump is not close to any ignition sources and there is ventilation available.

14. Decommissioning

Before carrying out this procedure, it is essential that the technician is completely familiar with the equipment and all its details. It is recommended good practice that all refrigerants are recovered safely. Prior to the task being carried out, an oil and refrigerant sample shall be taken in case analysis is required prior to re-use of reclaimed refrigerant. It is essential that electrical power is available before the task is commenced.

- 1) Become familiar with the equipment and its operation.
- 2) Isolate system electrically.
- 3) Before attempting the procedure, ensure that:
 - mechanical handling equipment is available, if required, for handling refrigerant cylinders;
 - all personal protective equipment is available and being used correctly;
 - the recovery process is supervised at all times by a competent person;
 - recovery equipment and cylinders conform to the appropriate standards.
- 4) Pump down refrigerant system, if possible.
- 5) If a vacuum is not possible, make a manifold so that refrigerant can be removed from various parts of the system.
- 6) Make sure that cylinder is situated on the scales before recovery takes place.
- 7) Start the recovery machine and operate in accordance with manufacturer's instructions.
- 8) Do not overfill cylinders. (No more than 80% volume liquid charge).
- 9) Do not exceed the maximum working pressure of the cylinder, even temporarily.
- 10) When the cylinders have been filled correctly and the process completed, make sure that the cylinders and the equipment are removed from site promptly and all isolation valves on the

equipment are closed off.

11) Recovered refrigerant shall not be charged into another refrigeration system unless it has been cleaned and checked.

15. Labeling

Equipment shall be labeled stating that it has been de-commissioned and emptied of refrigerant. The label shall be dated and signed. Ensure that there are labels on the equipment stating the equipment contains flammable refrigerant.

16. Recovery

When removing refrigerant from a system, either for servicing or decommissioning, it is recommended good practice that all refrigerants are removed safely.

When transferring refrigerant into cylinders, ensure that only appropriate refrigerant recovery cylinders are employed. Ensure that the correct number of cylinders for holding the total system charge are available. All cylinders to be used are designated for the recovered refrigerant and labeled for that refrigerant(i.e. Special cylinders for the recovery of refrigerant). Cylinders shall be complete with pressure-relief valve and associated shut-off valves in good working order .

Empty recovery cylinders are evacuated and, if possible, cooled before recovery occurs.

The recovery equipment shall be in good working order with a set of instructions concerning the equipment that is at hand and shall be suitable for the recovery of all appropriate refrigerants including, when applicable, flammable refrigerants. In addition, a set of calibrated weighing scales shall be available and in good working order. Hoses shall be complete with leak-free disconnect couplings and in good condition. Before using the recovery machine, check that it is in satisfactory working order, has been properly maintained and that any associated electrical components are sealed to prevent ignition in the event of a refrigerant release. Consult manufacturer if in doubt.

The recovered refrigerant shall be returned to the refrigerant supplier in the correct recovery cylinder, and the relevant waste transfer note arranged. Do not mix refrigerants in recovery units and especially not in cylinders.

If compressors or compressor oils are to be removed, ensure that they have been evacuated to an acceptable level to make certain that flammable refrigerant does not remain within the lubricant.

The evacuation process shall be carried out prior to returning the compressor to the suppliers.

Only electric heating to the compressor body shall be employed to accelerate this process. When oil is drained from a system, it shall be carried out safely.

17. Warning:

- 1) Do not use means to accelerate the defrosting process or to clean, other than those recommended by the manufacturer.
- 1) Ne pas utiliser de produits permettant d'accélérer le dégel ou de produits de nettoyage autres que ceux recommandés par le fabricant.
- 2) The appliance shall be stored in a room without continuously operating ignition sources (for example: open flames, an operating gas appliance or an operating electric heater).
- 2) L'appareil doit être entreposé dans un endroit sans source d'allumage fonctionnant en continu (par exemple: flamme nue, appareil au gaz en marche ou radiateur électrique en marche).
- 3) Do not pierce or burn.
- 3) Ne pas percer ni brûler.
- 4) Be aware that refrigerants may not contain an odour.
- 4) Attention : les frigorigènes peuvent être inodores.

18. Statement

- 1) Please use the flammable gas detector to check before unloading and open the container.
- 2) No fire source and smoking.
- 3) That pipe work shall be protected from physical damage and, in the case of FLAMMABLE REFRIGERANTS, shall not be installed in an unventilated space, if that space is smaller than Amin in Annex GG, except for A2L REFRIGERANTS where the installed pipes comply with UL 60335-2-40 Clause. In case of field charge, the effect on REFRIGERANT CHARGE caused by the different pipe length has to be quantified
- 4) That compliance with national gas regulations shall be observed.
- 5) Be shipped with a FLAMMABLE REFRIGERANT CHARGE. Joints made in the installation between parts of the REFRIGERATING SYSTEM, with at least one part charged, shall be made in accordance with the following.
 - A brazed, welded, or mechanical connection shall be made before opening the valves to permit refrigerant to flow between the REFRIGERATING SYSTEM parts. A vacuum valve shall be provided to evacuate the interconnecting pipe and/or any uncharged REFRIGERATING SYSTEM part.
 - Mechanical connectors used indoors shall comply with ISO 14903. When mechanical connectors are reused indoors, sealing parts shall be renewed. When flared joints are reused indoors, the flare part shall be re-fabricated.
 - Refrigerant tubing shall be protected or enclosed to avoid damage.
 - Flexible refrigerant connectors (such as connecting lines between the indoor and outdoor unit) that may be displaced during NORMAL OPERATION shall be protected against mechanical damage.
- 6) That pipe work including piping material, pipe routing, and installation shall include protection from physical damage in operation and service, and be in compliance with national and local codes

and standards, such as ASHRAE 15, ASHRAE 15. 2, IAPMO Uniform Mechanical Code, ICC International Mechanical Code, or CSA B52. All field joints shall be accessible for inspection prior to being covered or enclosed;

7) That after completion of field piping for split systems, the field pipe work shall be pressure tested with an inert gas and then vacuum tested prior to refrigerant charging, according to the following requirements;

8) The appliance shall be stored so as to prevent mechanical damage from occurring.

9) Working personnel for maintenance, service and repair operations. Every working procedure that affects safety means shall only be carried out by competent persons according to Annex HH.

Examples for such working procedures are:

- breaking into the refrigerating circuit;
- opening of sealed components;
- opening of ventilated enclosures.

Installation Safety Principles

1. Site Safety



Open Flames Prohibited

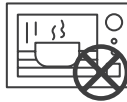

Ventilation Necessary

Operation Safety



Mind Static Electricity



Must wear protective clothing and anti-static gloves



Don't use mobile phone

2. Installation Safety

- Refrigerant Leak Detector
- Appropriate Installation Location



















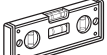

The left picture is the schematic diagram of a refrigerant leak detector.

Please note that:

- 1) The installation site should be well-ventilated.
- 2) The sites for installing and maintaining an air conditioner using Refrigerant R32 should be free from open fire or welding, smoking, drying oven or any other heat source higher than 54°C (129.2°F) which easily produces open fire.
- 3) When installing an air conditioner, it is necessary to take appropriate anti-static measures such as wear anti-static clothing and/or gloves.
- 4) It is necessary to choose the site convenient for installation or maintenance wherein the air inlets and outlets of the indoor and outdoor units should be not surrounded by obstacles or close to any heat source or combustible and/or explosive environment.
- 5) If the indoor unit suffers refrigerant leak during the installation, it is necessary to immediately turn off the valve of the outdoor unit and all the personnel should go out till the refrigerant leaks completely for 15 minutes. If the product is damaged, it is a must to carry such damaged product back to the maintenance station and it is prohibited to weld the refrigerant pipe or conduct other operations on the user's site.
- 6) It is necessary to avoid the places where there are other electrical products, power switch plugs and sockets, kitchen cabinet, bed, sofa and other valuables right under the lines on two sides of the indoor unit.

Suggested Tools

Tool	Picture	Tool	Picture	Tool	Picture
Standard Wrench		Pipe Cutter		Vacuum Pump	
Adjustable/ Crescent Wrench		Screw drivers (Phillips & Flat blade)		Safety Glasses	
Torque Wrench		Manifold and Gauges		Work Gloves	
Hex Keys or Allen Wrenches		Level		Refrigerant Scale	
Drill & Drill Bits		Flaring tool		Micron Gauge	
Hole Saw		Clamp on Amp Meter		Welding Gun	

Operating condition	
Inverter air conditioner:	
HEATING	Room temperature 0°C~27°C(32°F~81°F)
	Outdoor temperature -20°C~30°C(-4°F~86°F)
COOLING/ DRY	Room temperature 17°C~32°C(63°F~90°F)
	Outdoor temperature T1 climate: -15°C~53°C(5°F~127°F)

With the power supply connected, restart the air conditioner after shutdown, or switch it to other mode during operation, and the air conditioner protection device will start. The compressor will resume operation after 3 minutes.

Features of Protector
<p>1. The protective device will trip at following cases.</p> <ul style="list-style-type: none"> • Stop the appliance and restart it at once or change other modes during operation, you have to wait 3 minutes before restarting. • After switching on the power circuit breaker and then turn on the air conditioner at once, you have to wait about 20 seconds. <p>2. In case all operations have stopped, you need.</p> <ul style="list-style-type: none"> • Press "ON/OFF" button again to restart it. • Set TIMER once again if it has been canceled.

Noise pollution
<ul style="list-style-type: none"> • Install the air conditioner in a place that can bear its weight in order to operate more quietly. • Install the outdoor unit in a place where the air discharged and the operation noise do not annoy your neighbors. • Do not place any obstacles in front of the outlet of the outdoor unit for fear it affects operation and increases the noise level.

Inspection
<p>After a long time of operation, the air conditioner should be inspected for the following items.</p> <ul style="list-style-type: none"> • Abnormal heating of the power supply cord or even a burnt smell. • Abnormal operating noise or vibration. • Water leakage from indoor unit. • Metal cabinet electrified. • Stop using the air conditioner if above problem happened. • It is advisable that the air conditioner should be given a detailed check-up after using for five years even if none of the above happen.

Features of HEATING mode
<p>Preheat</p> <p>2-5 minutes are necessary to preheat the indoor heat exchanger at the beginning of "HEATING" operation, lest cold air be discharged.</p> <p>Defrost</p> <p>In "HEATING" operation the appliance will defrost automatically. This procedure lasts 2~10 minutes, then returns to "HEATING" mode automatically. During defrosting, indoor fan stop running and return to heating mode operation automatically when defrosting has finished.</p>

Refrigerant Sensor (Optional)

Important Notes:

1. The refrigerant sensor must be maintained by a professional and only the specified sensor by the manufacturer can be replaced.
2. The design life of the refrigerant sensor is 15 years, please replace the sensor within the range of the service life.
3. The refrigerant sensor automatically detects the condition of the machine while in operation, and will automatically start the circulating air flow and stop the compressor when the concentration reaches the alarm range.
4. The alarm signal of the refrigerant sensor is as follows table:

	Error Code
Refrigerant Leak Protection	Display "Hd"
The communication of the refrigerant sensor is abnormal	Display "Fd"

5. The installation position of the refrigerant sensor is shown in the figure below (for example, the appearance of different cabinets may be different)

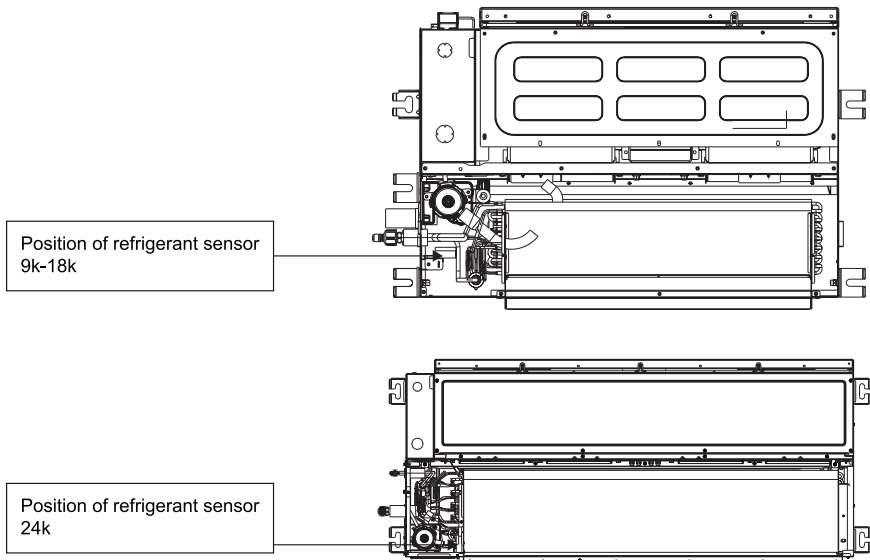

6. This unit is equipped with a refrigerant leak detector for safety. To be effective, the unit must be electrically powered at all times after installation, other than If you foresee not to use the device for a long time.
7. This refrigerant sensor shall only be replaced with manufacturer approved sensor.
8. LEAK DETECTION SYSTEM installed. Unit must be powered except for If you foresee not to use the device for a long time.

Parts and Functions

► Indoor Unit

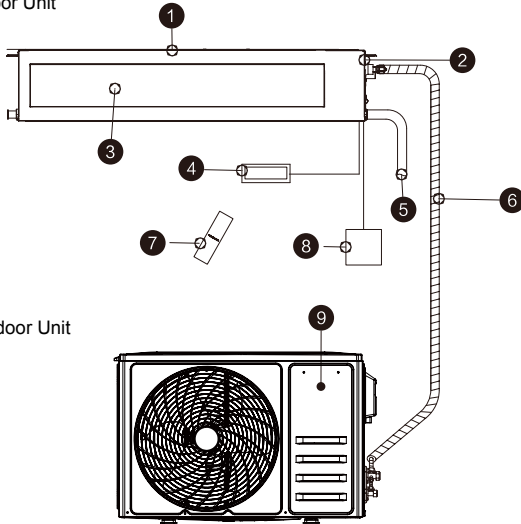

► Outdoor Unit

- ① Air inlet
- ② Electric control cabinet
- ③ Air Outlet
- ④ Remote control receiver
- ⑤ Drain pipe
- ⑥ Connecting pipe
- ⑦ Remote controller
- ⑧ Wire controller
- ⑨ Outdoor Unit

Actual product may vary from the image.

Requirements

- When the air temperature is below -15°C (5°F), the air conditioner cannot be started up until it's powered on for 2 hours. Further more, in case of a shut down lasting for about one day only, please do not cut off the electricity supply. (It is necessary to heat the crankcase heater so as to avoid force start of compressor.)
- The connection pipes, drain pipe, power cord, and duct for this unit should be prepared by the user.

About SLEEP operation

When the SLEEP operation is selected, the room temperature is automatically controlled with elapsed time so that the room isn't too cool during cooling or too warm during heating.

About power-off memory function

When the air conditioner disconnect the power suddenly, restart it, the air conditioner operates at the mode it did before power failed.











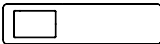



⚠ CAUTION





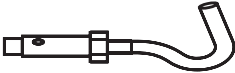





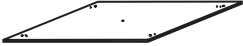

If any of the following conditions occur, stop the air conditioner immediately, set off the power switch, and contact the dealer.

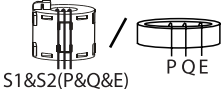
- Switch operations are erratic.
- The fuse is blown frequently or the circuit breaker is tripped frequently.
- Foreign matter or water has fallen inside the air conditioner.

Any other unusual condition is observed. Please check whether the following list of accessories are of full scope. If there are some spare items, please store them carefully aside.

Packing list:

Serial number	Name	Quantity	Sketch map
1	Remote control unit	×1	
2	Battery	×2	
3	Soundproof / insulation sheath (some models)	×1	
4	Soundproof / insulation sheath (some models)	×1	
5	Outlet pipe clamp ring assembly	×1	
6	Outlet pipe clasp (some models)	1~2 (Depending on models)	
7	Drain pipe assembly (some models)	×1	
8	Copper nut	2~4 (Depending on models)	
9	Instruction book	×1	
10	Suspension bolt (some models)	×4	
11	Ceiling hook (some models)	×4	
12	Throttle (some units)	×1	
13	Belt (some models)	×4	
14	Conduit installation plate (some models)	×1	
15	Hose clamp (some models)	×2	

16	Installation paper template (some models)	x1	
17	Anti-shock rubber (some models)	x1	
18	Drain joint (some models)	x1	
19	Seal ring (some models)	x1	
20	Magnetic ring (wrap the electric wires S1&S2 (P&Q&E) around the magnetic ring twice) (some models)	x1	
21	Magnetic ring (Hitch it on the connective cable between indoor unit and outdoor unit after installation.) (some models)	Varies by model	
22	Tapping screw (some models)	x4	
23	Mounting foot pads for the outdoor unit (some models)	x2	
24	Cable Clamp (some models)	x2	
25	Wired controller plate (some models)	x1	
26	Connecting pipe (some models)	x1	
27	Connecting wire (some models)	x1	
28	Drain joint (indoor unit)(some models)	x1	

Indoor Unit Installation

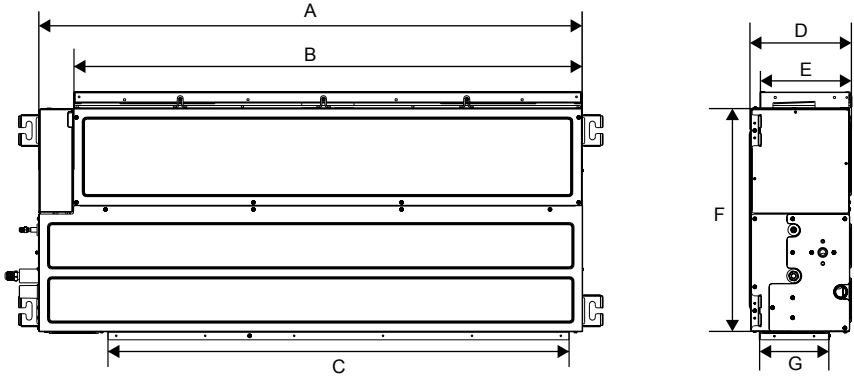

Unit: mm

Model	Indoor unit						
	A	B	C	D	E	F	G
9K-12K	700	600	513	200	189	452	146
18K	920	820	733	200	189	452	146
24K	1100	1030	934	200	189	452	146

Unit: in

Model	Indoor unit						
	A	B	C	D	E	F	G
9K-12K	27.6	23.6	20.2	7.9	7.4	17.8	5.7
18K	36.2	32.3	28.8	7.9	7.4	17.8	5.7
24K	43.3	40.5	36.8	7.9	7.4	17.8	5.7

INSTALLATION SPACE

Diagram of installation location and space for indoor unit (Notice: for the best performance of indoor unit, make sure its installation space conforms to the following installation dimensions).

Unit:mm

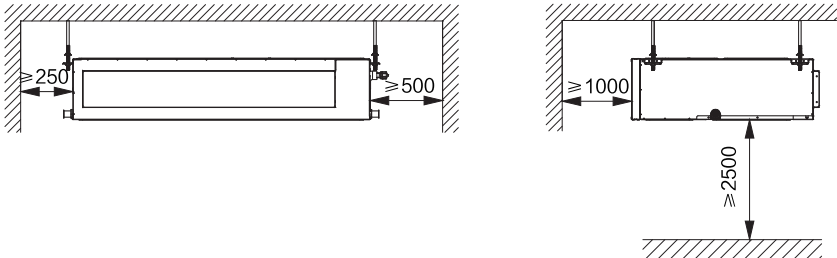

Preparation for Installing the Indoor Unit

⚠ NOTES

1. Please tighten the nut and bolt to prevent the air conditioner from falling down.
2. The unit might be loose if fixing the panel rack onl . Be careful during installation.

1. Install the bolts to the ceiling at a place strong enough to hang the unit. Mark the bolt positions from the installation template. With a concrete drill for 12.7mm diameter holes. See the following figure.

Unit:mm

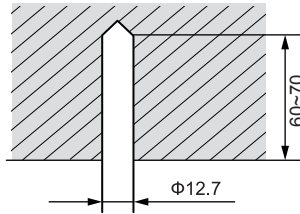

2. Insert the anchor bolts into the drilled holes, and drive the pins completely into the anchor bolts with a hammer. See the following figure.

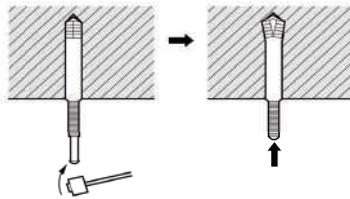

Ceiling-mounted

3. Install the hanger to the unit. See the following figure.

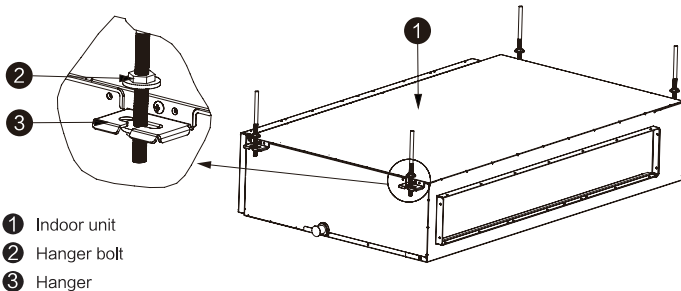

4. Pass the unit hangers over the bolts installed to the ceiling and install the unit with the special nut. As shown in the figure

Unit:mm

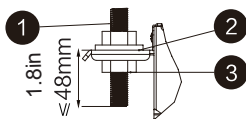
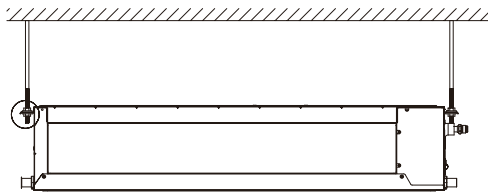

- ① Screw
- ② Hook
- ③ Nut

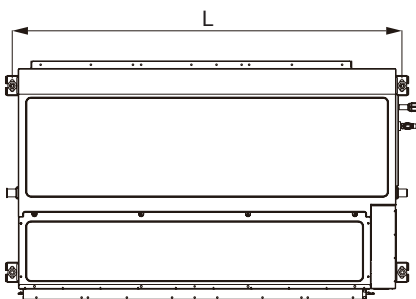

NOTE

Capacity Dimension	9/12K	18K	24K
L	738mm 29.1in	958mm 37.7in	1138mm 44.8in

⚠ CAUTION

Be sure to arrange the drain hose so that it is leveled lower than the drain hose connecting port of the indoor unit.

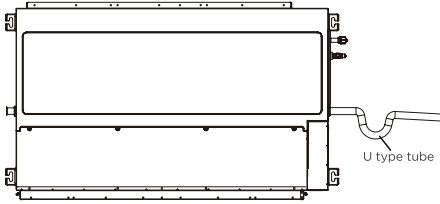

(Wall mounted, middle pressure model)

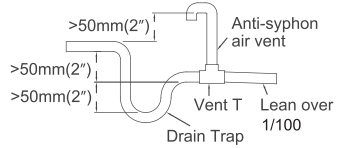

Leveling

After installing the indoor unit, level detection of the unit shall be conducted. Place the unit horizontally and the declivity of the drain pipe downwards should not be over 1/100, and no winding and bending.

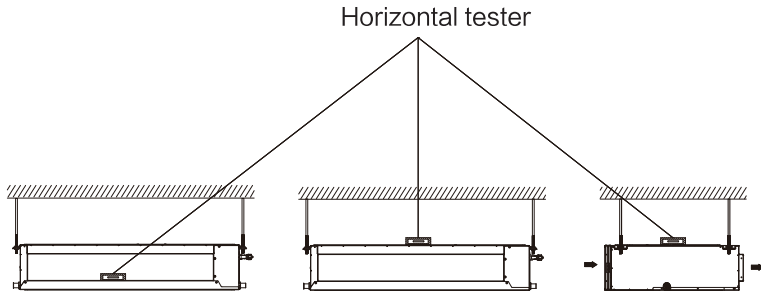

Installation Space

Ensure sufficient space for installation and repair.

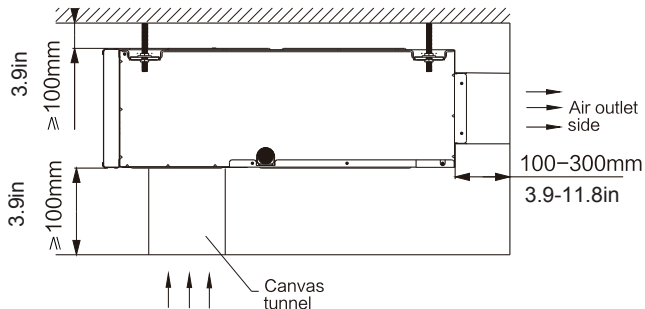

Unit:mm

Wooden construction

Put the square timber over the roof beam then install the hanging screw bolt.

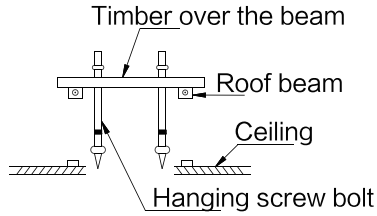

New concrete bricks

Inlaying or embedding the screw bolts

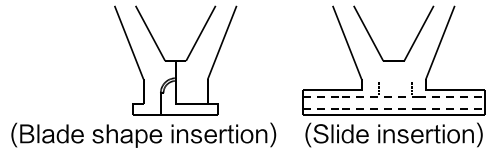

Finished concrete bricks

Install the hanging hook with expansion bolt into the concrete deep to 45-50mm to Hanging bolt prevent loose.

Steel roof beam structure

Make use of steel in the ceiling, or use hanging bolts and supporting angle steel.

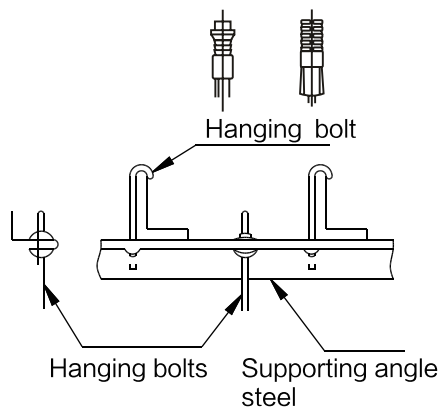

Hanging & Installation of indoor Unit

Adjust the nut position while the gap between gasket (downside) and ceiling should be confirmed according to actual situations.

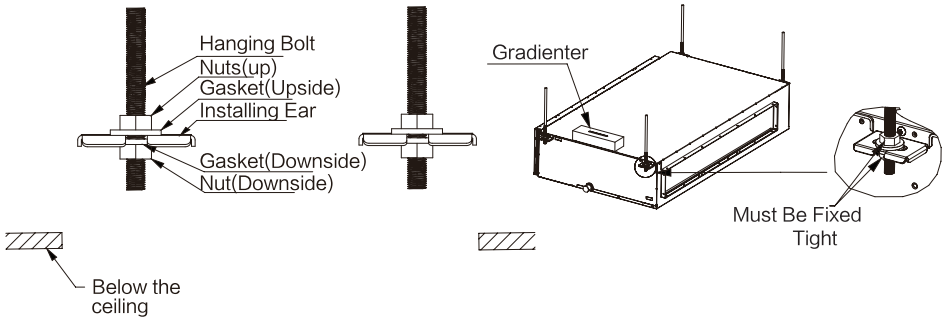

Hang the nut inside the U slot of the installation panel. To confirm level degree with gradienter .
(Leaning downside toward non-draining side is prohibited)

Drainage Pipe Connection

Refrigerant Adding

⚠ NOTES

Before and during operation, use an appropriate refrigerant leak detector to monitor the operation area and make sure the technicians can be well aware of any potential or actual leakage of inflammable gas. Make sure the leak detecting device is applicable to inflammable refrigerant. For example, it should be free of sparks, completely sealed and safe in nature.

Drill Wall Hole

A hole in the wall should be drilled for refrigerant piping, the drainage pipe, and connecting cables.

- 1) Determine the location of wall hole base on the position of mounting plate.
- 2) The hole should be have a 100mmn(3.93in) diameter at least and a small oblique angle to facilitate drainage.
- 3) Drill the wall hole with 100mm (3.93in) core drill and with small oblique angle lower than the indoor end about 5mm to 10mm.

Caution:

When drill the wall hole, make sure to avoid wires, plumbing and other sensitive components.

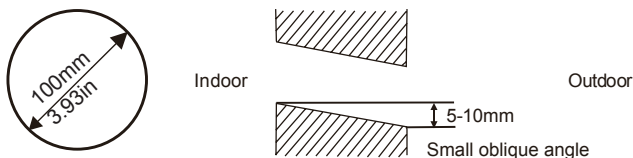

Installation of Drain Pipe

1. It is not allowed to connect the condensate drain pipe into waste pipe or other pipelines which are likely to produce corrosive or peculiar smell to prevent the smell from entering indoors or corrupt the unit.
2. It is not allowed to connect the condensate drain pipe into rain pipe to prevent rain water from pouring in and cause property loss or personal injury.
3. Condensate drain pipe should be connected into special drain system for air conditioner.

Indoor Side Drain Pipe

⚠ NOTES

Be sure to follow this Installation Manual during drainage installation, the drainage pipe must have the heat insulation to prevent condensing.

1. The drain pipe of indoor unit must have the heat insulation, or it will condense dew, as well as the connections of the indoor unit.
2. The declivity of the drain pipe downwards should not be over 1/100, and no winding and bending.
3. The total length of the drain pipe when pulled out transversely shall not exceed 20m, when the pipe is over long, a prop stand must be installed every 1.5 to 2m to prevent winding.
4. Refer to the following figures about the installation of the pipes. Do not impose any pressure on the connection part of the drainage pipe.

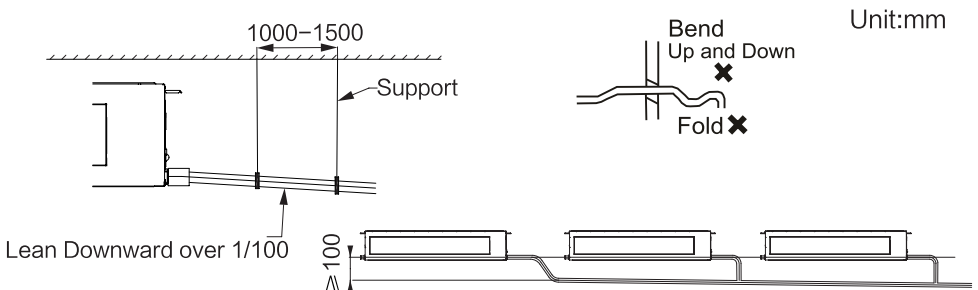

Drainage Pipe Material, Heat-insulating Material

The listed material should be used:

Drainage Pipe Material	Polyvinyl chloride pipe (φ32mm outer diameter)
Heat Insulation Material	Foamed polyethylene insulation plate (10mm thickness)

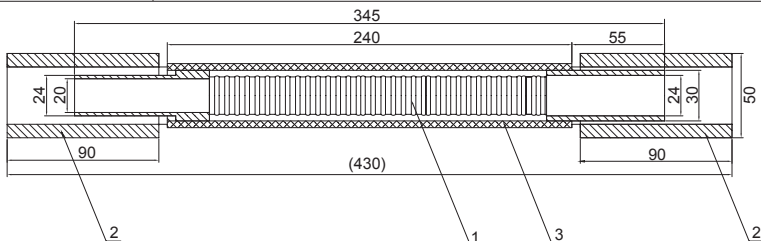

Drain nozzle dimension drawing

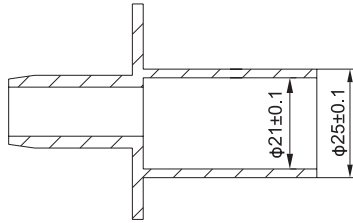

Advice:

The size of the purchased drain pipe should not be larger than the diameter of the pipe of the machine.

Connection Procedure

Connect the flexible pipe with the polyvinyl chloride pipe.

- The outer diameter of the purchased polyvinyl chloride pipe should be smaller than the inner diameter of the flexible hose. When the polyvinyl chloride pipe is much smaller in size than the flexible hose, glue should be applied on the polyvinyl chloride pipe and tape should be bundled to completely fit the flexible hose.
- Use polyvinyl chloride glue at the connection part of the drainage pipe, and make sure there is no water leakage.
- Apply glue to the front 40mm of the polyvinyl chloride pipe, then insert it into the flexible pipe until it can't be pushed in anymore.
- It needs 10 minutes for the glue to dry. Do not impose pressure on the connection during the drying period.
- Wind tape on the outside of the pipes to prevent the two pipes from falling off.

Heat Insulation

Wrap the flexible hose carefully with the attached heat insulation material from the start to the end (to indoor part)

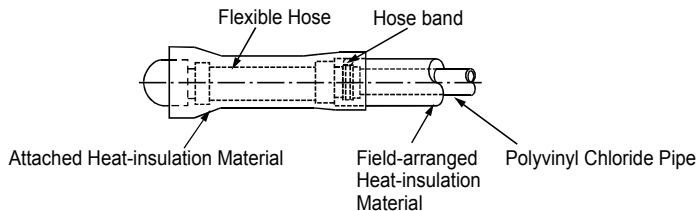

Outdoor Side Drain Pipe

1. If the outdoor unit is underneath the indoor unit, arrange the pipeline according to the following diagram.
- 1) Drain hose should be placed on the ground and its end should not be immersed into water. The whole pipeline should be supported and fixed onto the wall

2) Wind the insulating tape from bottom to top.

3) The whole pipeline should be wound with insulating tape and fixed onto the wall with saddles.

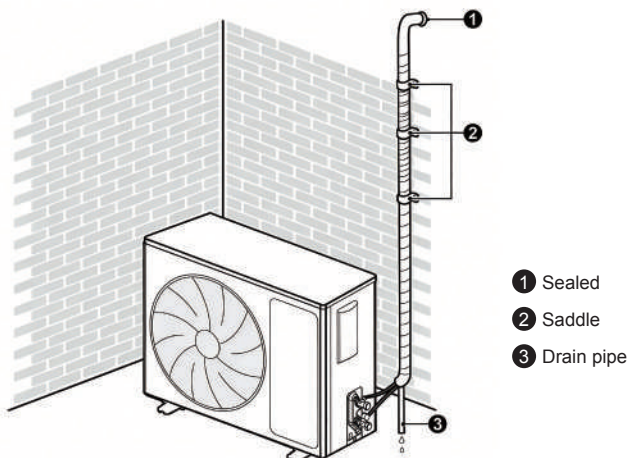

2. If the outdoor unit is above the indoor unit, arrange the pipeline according to the following diagram.

1) Wind the insulating tape from bottom to top.

2) The whole pipeline should be wound together to avoid water returning to the room.

3) Use saddles to fix the whole pipeline onto the wall.

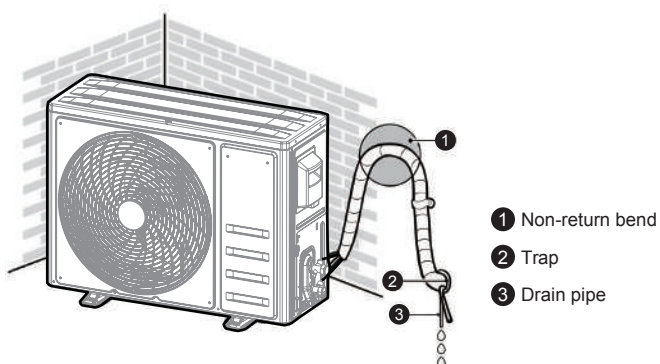

Drain Riser with Pump Unit Considerations

1. For the unit with the condensate pump, only one drain port at the side close to the electric box is prepared and only through it the drain hose can be connected.

Model	Item	Drain pipe (inside dimension)(mm)
9K/12K/18K/24K		Φ21

2. For the unit with the condensate pump, two drain ports at the bottom are defaulted to be factory

plugged with drain caps. After the installation of the drain hose, these two drain ports also need to be insulated properly with the same way aforementioned.

3. The lifted installation height of drainage pipe is less than 750mm, as is shown in the following figure.

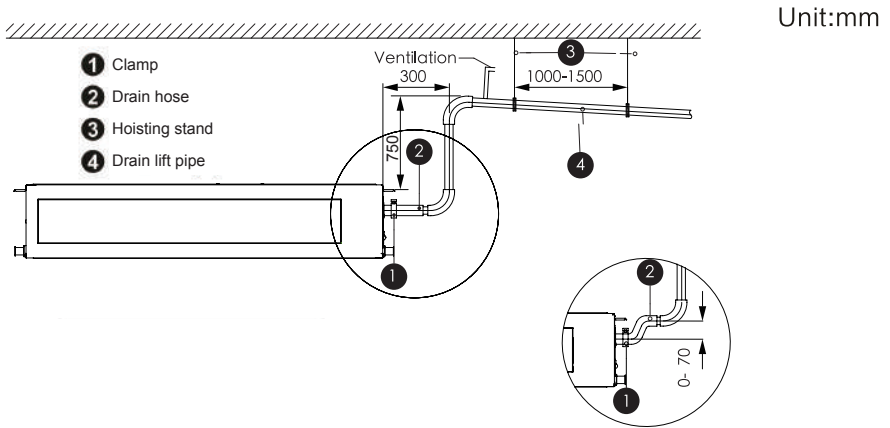

The vertical height of the drain hose should be 75mm (2.95in) or less so that it is unnecessary for the drain port to withstand additional force.

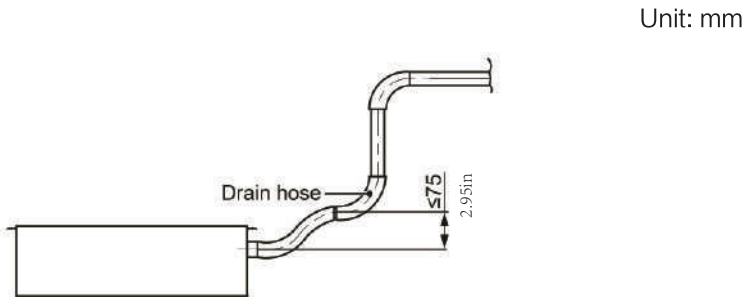

When multiple drain hoses are used, their installation should be performed as shown in the figure below.

Unit: mm

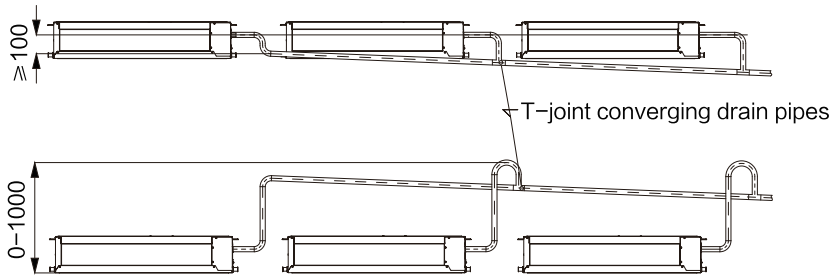

Check Drainage

After piping work is finished, check if drainage flows smooth .

As shown in the figure, add approximately 1 liter of water slowly into the drain pan and check drainage flow during COO running.

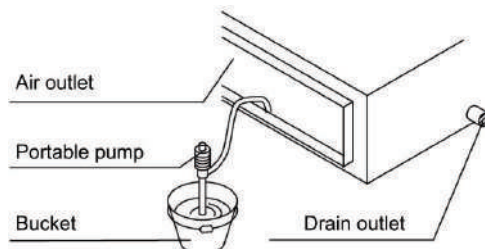

Installation of the Duct

1. How to mount outlet pipe

- 1) Generally, we have two types of outlet pipe available, i. e. rectangular or round ones.
- 2) Rectangular air conduit can be directly connected to air outlet of indoor unit by rivets. For outlet dimensions, see outline drawing of the unit.
- 3) Round air conduit should be connected to a piece of transitional air conduit before it is connected to air outlet of indoor unit, the other end of it can be separately connected to air conduit window or connected to air conduit window after air flow diversion, and the total length should not be over 6m. As shown in figure below, air speeds at all air outlets should be set to basically consistent so as to meet the room air-conditioning requirements.

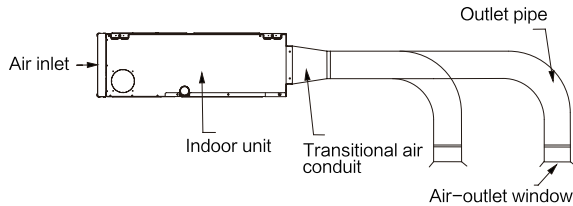

2. Choice of air return mode

This duct fan is equipped with two return air modes: rear return air and lower return air (initially rear return air mode). If necessary, please follow steps (2-4) to change it to lower return air mode.

1) Rear return air mode

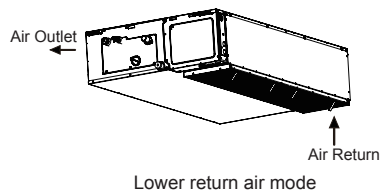
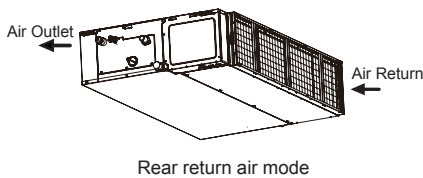

2) If the device you purchased is a left and right filter extraction device. First loosen the fixing screws of the filter screen, pull out the filter screen from the left or right, then loosen the fixing screws of the filter screen frame, remove the frame of the filter screen, and finally loosen the fixing screws of the return air bottom plate and remove the return air bottom plate. If the device you purchased is a front facing filter extraction device, first loosen the fixing screws of the magnetic filter and hold the filter handle with both hands to remove two magnetic filter screens from the front. Then loosen the screws that fix the return air base plate, filter frame, and machine body, and disassemble the two components as a whole (note: the screws connecting the return air base plate and filter frame do not need to be removed).

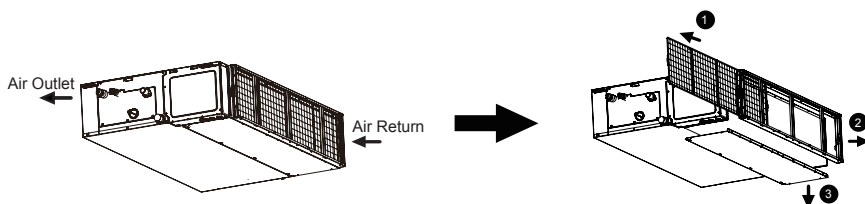

3) Now fix the return air bottom plate on the back of the machine, then fix the filter frame under the machine, and finally install the filter into the filter frame

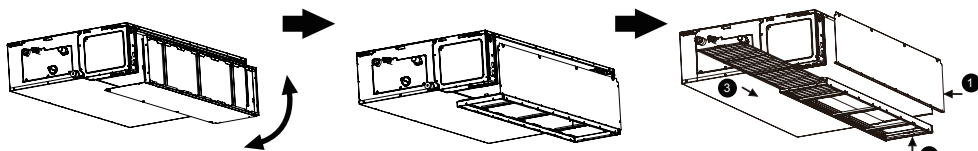

4) Return air method.

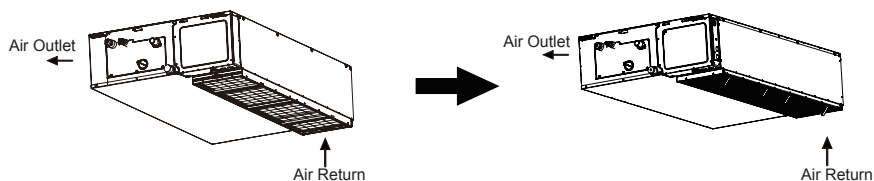

3. Installation method for return air pipe

- 1) In case sidewise air intake is adopted, return air pipe should be fabricated and rivet connected to return air orifice, and the other end of it should be connected to return air window .
- 2) In case of underside air intake, purchase or fabricate a section of pleated canvas air conduit serving as transition joint for return air orifice and return air window. In this way, it can be freely adjusted according to height of indoor ceiling board; in addition, during operation of the unit, canvas air conduit may avoid vibration of ceiling board, as shown in figure below .

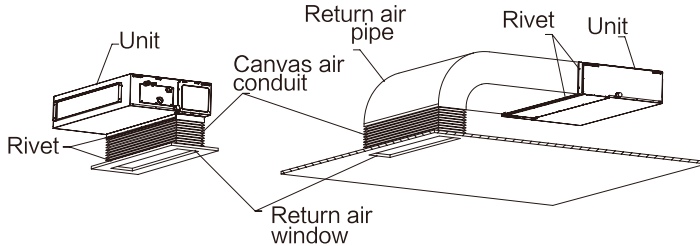

4. Tips for installation of return air pipe and outlet pipe

- 1) To minimize energy loss occurring in transmission process and condensed water during heating operation, return air pipe and outlet pipe should be equipped with heat-insulating layer as shown in the figure.

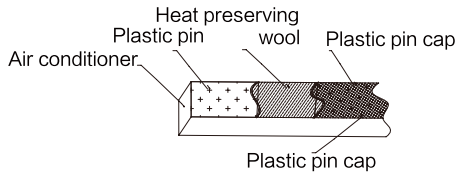

- 2) Return air pipe and outlet pipe should be fixed to floor precast slabs by iron stand; in addition, all ports of the air conduit should be tightly sealed by gasket cement and it is advisable that the edge clearance of return air pipe should be 150mm at least.
- 3) Drain pipe for condensed water should be installed with minimum gradient of 1%, and the drain pipe should be insulated with heat-preserving pipe casing as well.

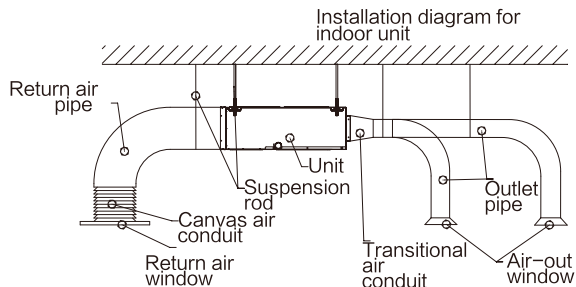

Outdoor Unit Installation

Split type outdoor unit

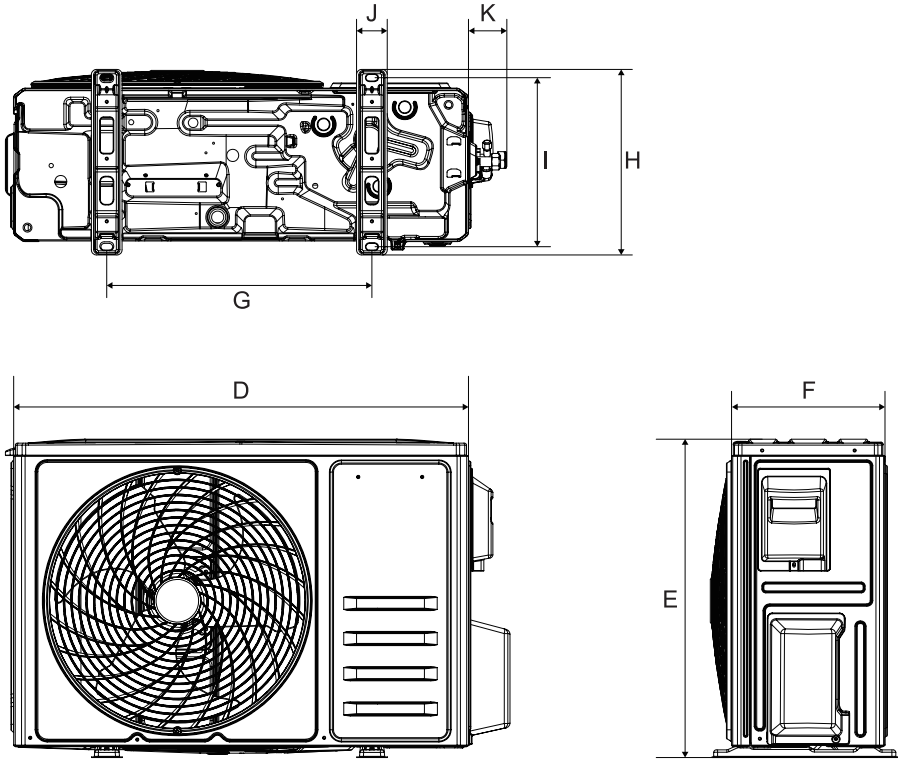

Unit: mm

Model	Outdoor unit							
	D	E	F	G	H	I	J	K
9K	722	498	240	415	290	263	48	59
12K	741	551	257	434	305	278	48	59
18K	794	602	292	516	349	314	54	58
24K	843	700	330	586	375	348	59	48

Unit: in

Model	Outdoor unit							
	D	E	F	G	H	I	J	K
9K	28.4	19.6	9.44	16.3	11.4	10.4	1.9	2.3
12K	29.2	21.7	10.1	17.1	12.0	10.9	1.9	2.3
18K	31.2	23.7	11.5	20.3	13.7	12.4	2.1	2.3
24K	33.1	27.5	13.0	23.1	14.8	13.7	2.3	1.9

Move outdoor unit

1. Please use 4 pieces of 6mm steel wire to lift the outdoor unit and move it to the desired location.
2. To prevent the outdoor unit from being deformed, please add baffle on the surface of the outdoor unit where the steel wires may come into contact.
3. After moving, please remove the wooden tray from the bottom.

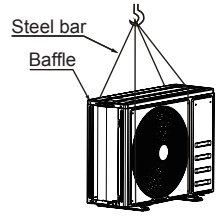

INSTALLATION SPACE

1. After leaving repair space as illustrated below, install the outdoor unit with power supply equipment installed at the side of the outdoor unit. Please refer to ELECTRIC SUPPLY INSTALLATION MANUAL for the installation method.
2. Please make sure necessary space for installation and repair.

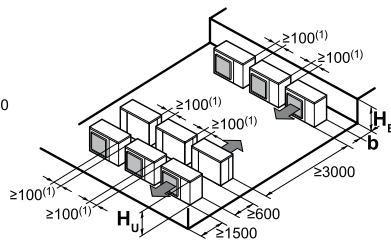
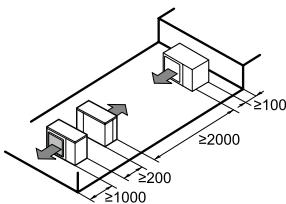
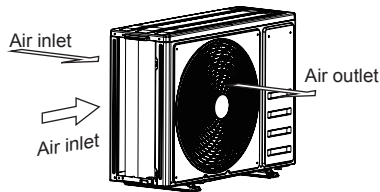

H_B H_U	b (mm)
$H_B \leq \frac{1}{2}H_U$	$b \geq 250$
$\frac{1}{2}H_U < H_B \leq H_U$	$b \geq 300$
$H_B > H_U$	/

Refrigerant pipes

1. The junction is inside the cover of the right panel. Please remove the cover first.
2. Route the pipe through the side gap of the cover.
3. After connecting via the valve opening, reinstall the cover from the left, right, or back for installation.
4. The diagram on the right is the schematic diagram of the outdoor unit's valve installation panel. The gas side (low-pressure side) is oriented upward, and the liquid side is oriented downward.

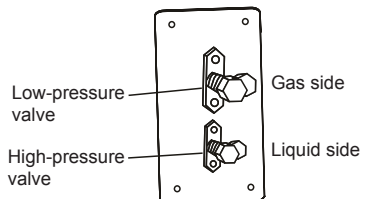

INSTALLATION

Pre-installation precautions

- Please confirm that the installation personnel are qualified for relevant installation work. If the air conditioner is installed by persons without special skills, normal operations will not be ensured, and even personal and property safety will be affected.

User guideline

- The user's installation site should be provided with a regular power supply conforming to that indicated on the air conditioner's nameplate, and its voltage should be within the range of 90% - 110% of the rated voltage value.
- The power circuit should be equipped with a protective device, such as a leakage protector or an air switch, which should have a capacity greater than 1.5 times the maximum current value of the air conditioner.
- Always use a dedicated circuit and a properly-grounded socket compatible with the air conditioner's attached plug. The attached plug is equipped with a grounding pin, and it must not be modified at will.
- Please use the fuse or circuit breaker prescribed in the Installation Instructions.
- Only a qualified electrician is allowed to carry out wiring tasks strictly according to electrical safety requirements.
- Do ensure proper grounding of the air conditioner; in other words, the main power switch of the air conditioner must be connected to a reliable ground wire.

Precautions

- The air conditioner should be installed securely; otherwise poor installation may lead to abnormal noise and vibration.
- Outdoor unit should be installed at a spot ensuring that its air outlet noises and hot exhaust will not violate your neighbors.

Unit body installation

1. Mark the installation position for expansion bolts according to the outdoor unit's installation dimensions.
2. Drill holes, clean the concrete dust, and insert the expansion bolts.
3. If applicable, install 4 rubber pads on the installation holes before placing the outdoor unit (Optional).
4. Doing so will reduce vibrations and noise.
5. Place the outdoor unit onto the bolts and pre-drilled holes.
6. Use a wrench to firmly secure the outdoor unit with the bolts.

Note:

The outdoor unit can be fixed on a wall-mounting bracket.

Follow the wall-mounting bracket's instructions to attach the bracket to the wall. Then, fasten the outdoor unit to the bracket and ensure it is level.

The wall-mounting bracket must support at least 4 times the weight of the outdoor unit.

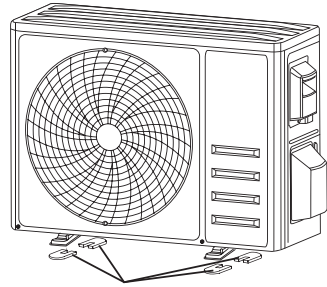

Install 4 rubber blankets (Optional)

Install Drainage Hose

1. This step only for heat pump models or RCACs.
2. Insert the drainage joint to the hole at the bottom of the outdoor unit.
3. Connect the drainage hose to the joint and make the connection well enough.

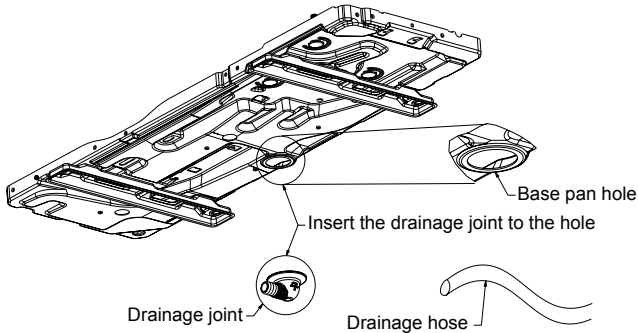
**NOTE:**

Before bolting the outdoor unit in place, you must install the drain joint at the bottom of the unit. For units with a base pan built-in (with multiple holes for proper draining during defrost), the drain joint is not needed to be installed.

In cold climates, ensure the drain hose is as vertical as possible to ensure swift water drainage. If water drains too slowly it can freeze in the hose and flood the unit.

Refrigerant Pipes Installation

Pipe dimension and ways of installation

Outdoor pipe dimension and ways of install (in sequence of cooling capacity)

Pipe Material		Copper Pipe for Air Conditioner		
Model		9~18K	24K	36K
Size(mm)	Liquid side	Φ6.35 (1/4inch)	Φ6.35 (1/4inch)	Φ6.35 (1/4inch)
	Gas side	Φ9.52(3/8inch)	Φ12.7(1/2inch)	Φ15.88(5/8inch)

Please refer to refrigerant pipe connection for detail

Allowed length and height drop

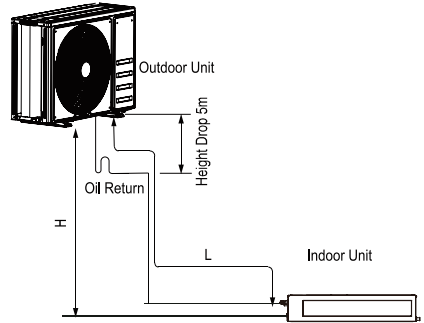

Remove objects and water

- Use high-pressure nitrogen to clean the pipe instead of using outdoor refrigerant for this cleaning process.
- Before installing the refrigerant pipe, please clean the pipe to prevent foreign objects from being inside.

Additional refrigerant charge

- The additional charge is based on the diameter and length of the outlet and inlet liquid pipes.
- This AC has been charged with a standard amount of refrigerant for 7.5m connection pipes. Connection pipes beyond 7.5m should be additionally charged as follows.

Inverter Models Capacity (Btu/h)	9K/12K	18K/24K	36K
Length of pipe with standard charge	7.5m/25ft	7.5m/25ft	7.5m/25ft
Maximum distance between indoor and outdoor unit	15m/49ft	20m/65ft	30m/98ft
Additional refrigerant charge	10g/m	10g/m	10g/m
Max. diff. in level between indoor and outdoor unit	10m/33ft	15m/49ft	20m/65ft
Type of refrigerant	R32		

Note: Some connecting pipe sizes differ from the outdoor unit specifications. An adapter is required for installation.

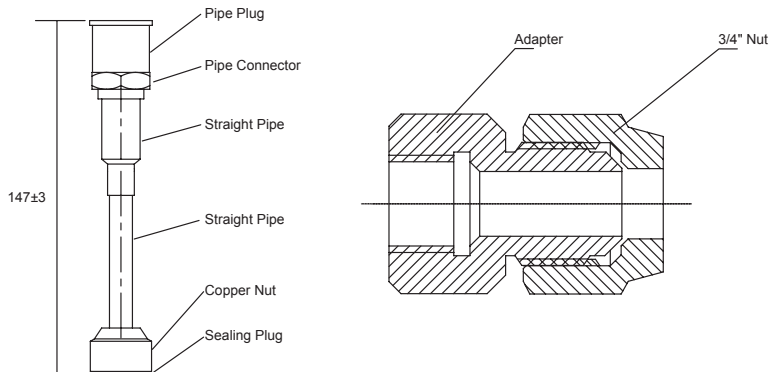

Refrigerant charge label

Please fill in with indelible ink.

- ① The factory refrigerant charge of the product,
- ② The additional refrigerant amount charged in the field and
- ① + ② the total refrigerant charge on the refrigerant charge label supplied with the product.

Affix the refrigerant charge label near the manufacturer's label after filling it out.

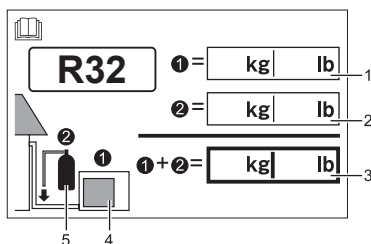

1. Factory refrigerant charge of the product: see unit manufacturer's label.
2. Additional refrigerant amount charged in the field.
3. Total refrigerant charge.
4. Outdoor unit.
5. Refrigerant cylinder and manifold for charging.

Non-return bend and oil return bend

1) When outdoor unit is beneath the indoor unit.

There's no need to add non-return bend at the lowest or highest position of the vertical pipe, as shown below:

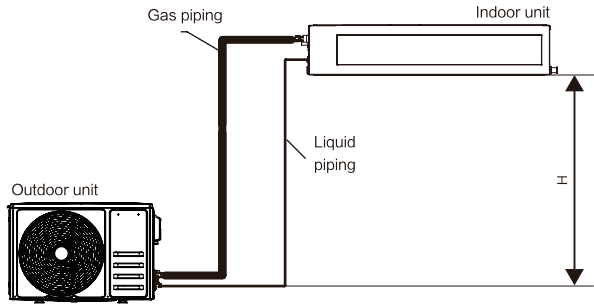

2) When outdoor unit is above the indoor unit.

It's necessary to add oil return bend and non-return bend at the lowest and highest position of the vertical pipe, as shown below:

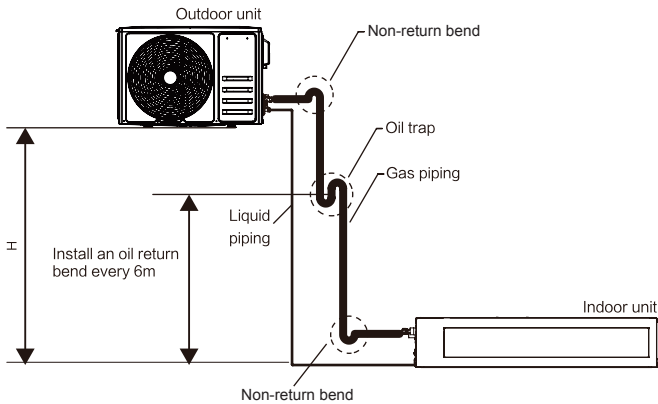

Dimensions for the making of oil return bend are as follows:

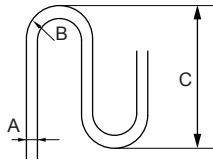

A(inch)	B(mm)	C(mm)
Φ3/8	≥20	≤150
Φ1/2	≥26	≤150
Φ5/8	≥33	≤150

FLARING

1. Cut the refrigerant pipe off with a pipe cutter .

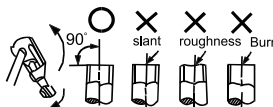

2. Flare the pipe after putting it into the connection nut.

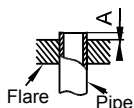

Outside Diameter	A(mm)	
	MAX	MIN
Φ1/4"	8.7	8.3
Φ3/8"	12.4	12.0
Φ1/2"	15.8	15.4
Φ5/8"	19.0	18.6
Φ3/4"	23.3	22.9

Stop valve operation item

- Open the valve rod until it reaches the stop position. Do not attempt to open it further.
- Fasten the valve bonnet with a spanner or other similar tools.
- Ensure the valve rod bonnet is securely fastened.

Junction Fixture

Aim at the connection pipe, fix the nut of the connection pipe, and then tighten it with a spanner as shown in the following diagram.

⚠ Notice

According to the installation conditions, an excessively large tightening torque will damage the nut.

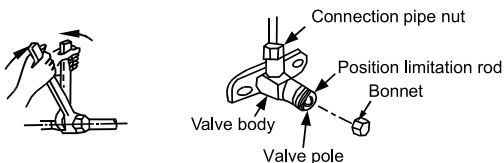

Pipe Size	Newton meter(N x m)	Pound-force foot(lbf-ft)	Kilogram-force meter(kgf-m)
1/4" (φ6.35)	15-20	11.1-14.8	1.5-2.0
3/8" (φ9.52)	31-35	22.9-25.8	3.2-3.6
1/2" (φ12)	45-50	33.2-36.9	4.6-5.1
5/8" (φ15.88)	60-65	44.3-48.0	6.1-6.6

⚠ Note: This table is only for reference, the installation shall meet the requirements of local laws and regulations.

- The following figure only shows the assembly relationship of the indoor unit, outdoor unit and refrigerant pipes.
- Please refer to the following figures to install.

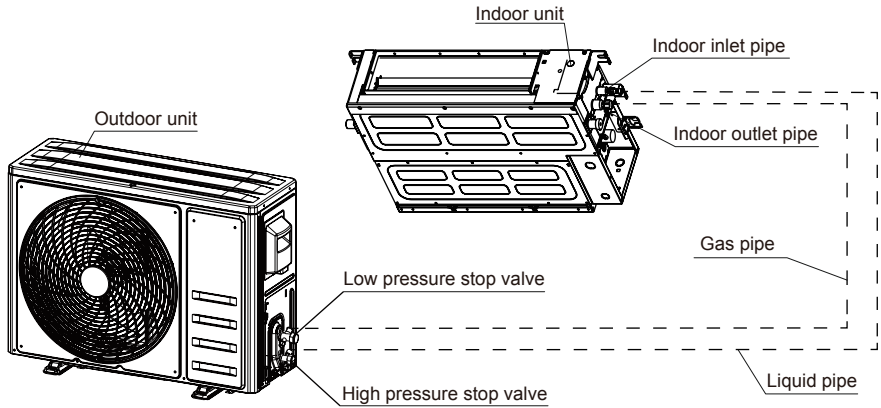

NOTE

- The throttle subassembly has been installed in the outdoor unit.
- Use two spanners to connect the pipe with indoor/outdoor pipes to avoid the copper pipe cracking.
- Please pay attention to the connection orientation when connecting.

Joints shall be tested with detection equipment with a capability of 5g/year of refrigerant or better, with the equipment in standstill and under operation or under a pressure of at least these standstill or operation conditions.

Electric Wiring

CAUTION

- Be sure to install Current Leakage Protection Switch.
 - Or electric shock may occur.
 - The appliance must be positioned so that the plug is accessible.
 - The appliance shall be installed in accordance with national wiring regulations.
1. Power cord is to be selected according to national regulations.
 2. Outdoor unit power cord should be selected and connected according to the outdoor unit installation manual.
 3. Wiring should be away from high temperature components, or the insulation layer of the wires may melt down.
 4. Use wire clamp to fix the wires and terminal block after connection.
 5. Control wire should be wrapped together with heat insulated refrigerant pipes.
 6. Connect the indoor unit to power only after the refrigerant has been vacuumed.
 7. Don't connect the power wire to the signal wire connection end.

Terminal Board Diagram

Please refer to indoor unit wiring for the wiring.

1. Binding treatment

Once the connecting wires have been properly connected, bind the connecting tubing, connecting wire and drain pipe by binding tapes.

After binding treatment, the cross section is shown in the figure below

Notice: Drain pipe must not be flattened during binding treatment.

Drain pipe outlet should be led to a place that can avoid affecting the environment.

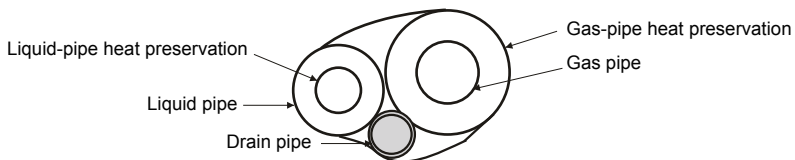

- Open or close incorrectly.
- Objects or water into the AC.
- Fuse or electric leakage protector breaks for several times.

Install Wiring

1. Use a Phillips screwdriver to unscrew wiring cover, grasp and press it down gently to take it down.
2. Unscrew the cable clamp and take it down.
3. According to the wiring diagram pasted inside the wiring cover, connect the connecting wires to the corresponding terminals, and ensure all connections are firmly and secure .
4. Reinstall the cable clamp and wiring cover.

Note: When connecting the wires of indoor and outdoor units, the power should be cut off

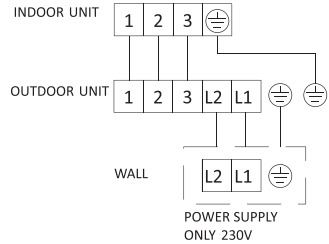
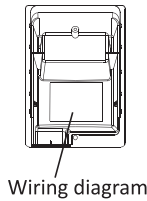
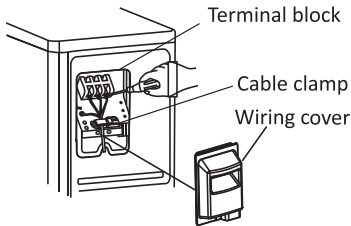

Dedicated Distribution Device and Wire for Air Conditioner

Wiring material ampacities	AWG
4	22
7	20
10	18
13	16
18	14
25	12
30	10
40	8
55	6
70	4

⚠ Note: This table is only for reference, the installation shall meet the requirements of local laws and regulations. The suitable temperature for selecting wire gauge is $25^{\circ}\text{C}\pm 5^{\circ}\text{C}$ ($77^{\circ}\text{F}\pm 41^{\circ}\text{F}$).

Air Purging

Use a vacuum pump to vacuum from the gas-side refrigerant charging port of the outdoor unit.

If air and moisture remain inside the refrigeration system, they may have the following adverse effects

- A rise in pressure inside the refrigeration system;
- A decrease in cooling effect
- Moisture freezing and blocking the refrigeration system;
- Rusting of certain system components.
- Don't use the outdoor unit's refrigerant to perform vacuuming. (A certain volume of refrigerant was added to the outdoor unit at the factory.)

- When a vacuum pump is used, each low-pressure valve must be operated as follows.

Please refer to the operation manual for the usage of the manifold valve.

1. Use a spanner to take down the protective caps from the service port, low pressure valve and high pressure valve of the outdoor unit.
 2. Connect the pressure hose of manifold gauge to the service port on the outdoor unit low pressure valve.
 3. Connect the charge hose from the manifold gauge to the vacuum pump.
 4. Open the low pressure valve of the manifold gauge and close the high pressure valve.
 5. Turn on the vacuum pump to vacuum the system.
 6. The vacuum time should not be less than 15 minutes, or make sure the compound gauge indicates $-0.1\text{ MPa}(-76\text{ cmHg})$.
 7. Close the low pressure valve of the manifold gauge and turn off the vacuum.
 8. Wait for 5 minutes, then check that there has been no change in system pressure.
 9. Open the low pressure valve counterclockwise for $1/4$ turn with hexagonal wrench to let a little refrigerant fill in the system, and close the low pressure valve after 5 seconds and quickly remove the pressure hose.
 10. Check all indoor and outdoor joints for leakage with soapy water or leak detector.
 11. Fully open the low pressure valve and high pressure valve of the outdoor unit with hexagonal wrench.
 12. Reinstall the protective caps of the service port, low pressure valve and high pressure valve of the outdoor unit.
 13. Reinstall the valve cover.
- Please refer to the following figure to install.

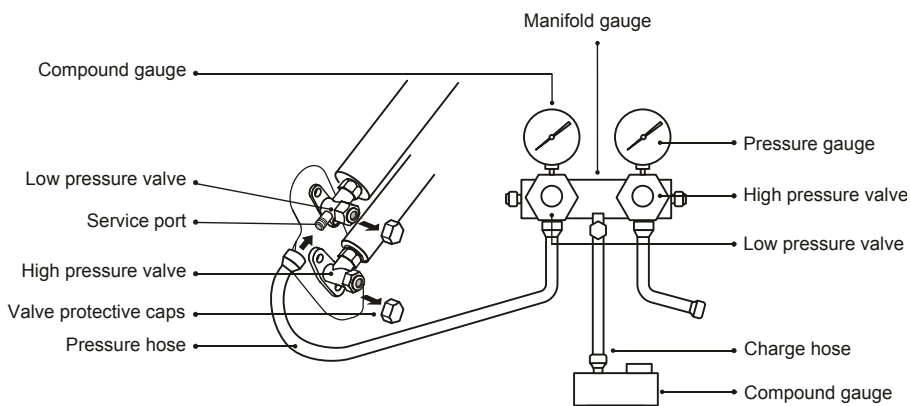

Test Run

Before testing

1. Check if piping, drainage and external wiring have been finished correctly.
2. Check if the power supply complies with requirements; if there is refrigerant leakage; if the all wires and cables are correctly connected and well fixed.

Function test

1. After checking, energize your appliance and press the buttons on the control panel to see if the buttons function;
2. If LCD screen displays normally.

Notes

1. Please read this operating and installation instructions carefully.
2. Do not let air in or refrigerant out during installing or reinstalling the appliance.
3. Test run the air conditioner after finishing installation and keep the record.
4. Type of fuse for controller of indoor unit is 50CT/524, rated specification is T5A, 250VAC. Fuse for the whole unit is not supplied by the manufacturer, so the installer must employ a suitable fuse or other over-current protective device for the power supply circuit according to the maximum power input as required.
5. The air conditioner operates safely when ambient static pressure is 0.8~1.05 standard atmosphere pressure.

Checks Before Operation

CAUTIONS

1. Check that the wiring is not broken off or disconnected.
2. Check that the air filter is installed. (Some air-conditioners have no air filters)
3. Check that the outdoor unit air outlet or inlet is not blocked. Disconnect the power supply before cleaning the air conditioner.
4. Check the access control and dry contact interfaces on the electrical control board—they cannot be connected simultaneously. Only one should be connected at a time.

Clean the air filter

- The air filter can prevent the dust or other particulate from going inside. In case of blockage of the filter, the working efficiency of the air conditioner may greatly decrease. Therefore, the filter must be cleaned once two weeks during long time usage.
- If the air conditioner is positioned in a dust place, the cleaning frequency of the air filter must be increased.
- If the accumulated dust is too heavy to be cleaned, please replace the filter with a new one (replaceable air filter is an optional fitting)

Maintenance

Cleaning

Warning: please shut down the unit and cut off the power before cleaning for safe

Cleaning the unloaded filte

1. Clean the unloaded filter with vacuum cleaner or water.
2. Scrub with neutral detergent if the filter is too dirty. Do not wash with hot water (about above 122°F), in case it is out of shape.
3. Place it on a ventilated place and cannot be under the sunshine directly after washing lest it is out of shape.
4. For your purchasing unit is a rear ventilated device, please remove the filter fixed screws (2 screws), then remove the filter screen from the left side of the machine or the fabric side. If it is another type of filter, from the front of the machine's return air outlet side.
5. For your purchasing unit is a descensional ventilated device, please remove the filter fixed screws(2 screws), then remove the filter screen from the left side of the machine or the fabric side. If it is another type of filter, remove the filter from the front of the machine's return air outlet side.

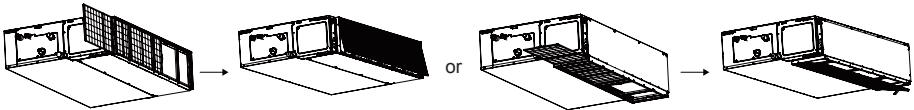

Maintenance

1. Please do the following job well if the air conditioner is not used for a long time in order to dry the unit completely, set the FAN mode and runs for 3-4 hours. Shut down the air conditioner and cut off the power supply.
2. When used again after the unit stops for a long period: When cleaning the filter and indoor unit, you must stop the unit and cut off power supply Wipe the indoor unit with soft cloth. It is forbidden to push the machine with petrol, benzene, lye, powder, detergent, insecticide etc. Which will damage the unit.
3. Ensure air inlet and outlet of indoor and outdoor unit are not blocked by rubbish. Check whether the grounded wire is loose and flexible, then connect the powe .

DISPLAY PANEL(Optional)

1. Trouble display of indoor display panel

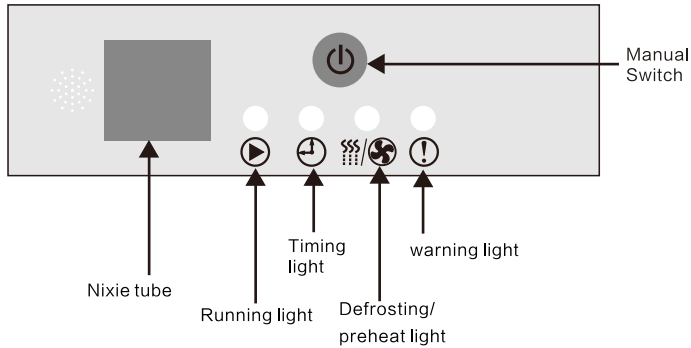

Display function declaration :

LED light the state of running light

- 1) When powered-on the first time, the running light twinkles, while the double-8 does not lit.
- 2) When started—up normally, the running light lights on, while the double-8 shows the ambient temperature.
- 3) When operated normally, the running light lights on, while the double-8 shows the ambient temperature.
- 4) When closed down, both LED and double-8 are gone out.

LED light the state of Timing light

- 1) When timing set, the timing light lights on, and the double-8 flash shows the time setting within 5 seconds, then shows the ambient temperature.
 - 2) When without time setting, the timing light gone out, while the double-8 back to the original state.
- LED light the state of defrosting/preheat light.

- 3) When in the state of defrost, oil return, cold-wind proof, the defrosting/preheat light lights on, while the double-8 shows the designed temperature. (One-driven-one does not show the oil return state).
- 4) When out of the state of defrost, oil return, cold-wind proof, the defrosting/preheat light gone out, while the double-8 shows the designed temperature. (One-drive-one does not show the oil return state). LED light the state of warning light.
- 5) When double-8 shows E* or P*, the running lights gone out, while the warning light lights on.

2. Trouble display of outdoor unit

- 1) During standby, the digital tube displays the numbers of indoor unit currently connected and communicating.
- 2) When the compressor operates, the digital tube displays the frequency value of the inverter compressor.
- 3) The digital tube displays “dxx” during defrosting; The digital tube displays “Cxx” during oil return.
- 4) During trouble protection, the information code displayed by the digital tube as follows.
(Troubleshooting)

NOTES

- Before cleaning, please make sure the unit is stopped. Cut the circuit breaker and remove the power socket, otherwise, electric shock may occur.
- Do not wash the air conditioner with water, otherwise fire hazard or electric shock may occur.
- When cleaning the filter, please be careful of your steps. If you need to work high above the ground, please be extremely careful.

3. Filter screen cleaning

Increase the frequency of cleaning if the unit is installed in a room where the air is extremely contaminated (As a yardstick for yourself, consider cleaning the filter once a half year).

If dirt becomes impossible to clean, change the air filter. (Air filter for exchange is optional.)

- 1) Removing the air filter from the duct.
- 2) Cleaning the air filter.
Remove dust from the air filter using a vacuum cleaner and gently rinse them in cool water. Do not use detergent or hot water to avoid filter shrinking or deformation. After cleaning dry them in the shade.
- 3) Replacing the air filter and Reinstall the filter as before

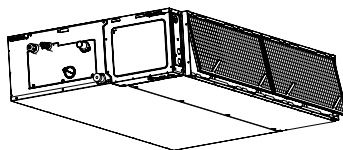
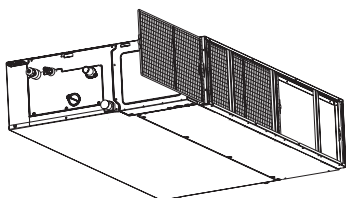

4. Heat Exchanger of Outdoor Unit

Conduct cleaning for the heat exchanger of outdoor unit periodically, clean it once at least in every two months. Clean the dust and sundries on the surface of the heat exchanger with dust collector and nylon brush, if there's compressed air source; use the compressed air to blow the dust on the surface of the heat exchanger. Don't use tap water for cleaning.

5. Drainage Pipe

Periodically check if the drainage pipe is blocked to smooth the condensate water.

6. Notices at the Beginning of the Using Season

- 1) Check if the air inlet/outlet of indoor/outdoor unit is blocked.
- 2) Check if the ground connection is reliable.
- 3) Check if the battery of remote controller is replaced.
- 4) Check if the air filter screen is properly installed.
- 5) If starting up again after long-term shut down, preset the power switch of air conditioner to “ON” status before 8h of operation, to preheat the crankcase of outdoor compressor.
- 6) Check if the installation of outdoor unit is firm.

7. Maintenance at the End of the Using Season

- 1) Cut off the main power of air conditione .
- 2) Clean the filter screen, indoor and outdoor unit.
- 3) Clean the dust and sundries in indoor and outdoor unit.
- 4) If the outdoor unit is rusty, coat the rusty location with paint to prevent it from expanding.

8. Notice on Maintenance

Information on Servicing

The manual shall contain specific information for service personnel who shall be instructed to undertake the following when servicing an appliance that employs a flammable refrigerant.

- Checks to the Area

Prior to beginning work on systems containing flammable refrigerants, safety checks are necessary to ensure that the risk of ignition is minimized. For repair to the refrigerating system, the following precautions shall be complied with prior to conducting work on the system.

- Work Procedure

Work shall be undertaken under a controlled procedure so as to minimize the risk of a flammable gas or vapour being present while the work is being performed.

- General Work Area

All maintenance staff and others working in the local area shall be instructed on the nature of work being carried out. Work in confined spaces shall be avoided. The area around the workspace shall be sectioned off. Ensure that the conditions within the area have been made safe by control of flammable material.

- **Checking for Presence of Refrigerant**

The area shall be checked with an appropriate refrigerant detector prior to and during work, to ensure the technician is aware of potentially flammable atmospheres. Ensure that the leak detection equipment being used is suitable for use with flammable refrigerants, i. e. non-sparking, adequately sealed or intrinsically safe.

- **Presence of Fire Extinguisher**

If any hot work is to be conducted on the refrigeration equipment or any associated parts, appropriate fire extinguishing equipment shall be available to hand. Have a dry powder or CO₂ fire extinguisher adjacent to the charging area.

- **No Ignition Sources**

No person carrying out work in relation to a refrigeration system which involves exposing any pipe work that contains or has contained flammable refrigerant shall use any sources of ignition in such a manner that it may lead to the risk of fire or explosion. All possible ignition sources, including cigarette smoking, should be kept sufficiently far away from the site of installation, repairing, removing and disposal, during which flammable refrigerant can possibly be released to the surrounding space. Prior to work taking place, the area around the equipment is to be surveyed to make sure that there are no flammable hazards or ignition risks. "No Smoking" signs shall be displayed.

- **Ventilated Area**

Ensure that the area is in the open or that it is adequately ventilated before breaking into the system or conducting any hot work. A degree of ventilation shall continue during the period that the work is carried out. The ventilation should safely disperse any released refrigerant and preferably expel it externally into the atmosphere.

- **Checks to the Refrigeration Equipment**

When electrical components are being changed, they shall be fit for the purpose and to the correct specification. At all times the manufacturer's maintenance and service guidelines shall be followed. If in doubt consult the manufacturer's technical department for assistance.

The following checks shall be applied to installations using flammable refrigerants:

- 1) The charge size is in accordance with the room size within which the refrigerant containing parts are installed.
- 2) The ventilation machinery and outlets are operating adequately and are not obstructed.
- 3) If an indirect refrigerating circuit is being used, the secondary circuit shall be checked for the presence of refrigerant.

-
- 4) Marking to the equipment continues to be visible and legible. Markings and signs that are illegible shall be corrected.
 - 5) Refrigeration pipe or components are installed in a position where they are unlikely to be exposed to any substance which may corrode refrigerant containing components, unless the components are constructed of materials which are inherently resistant to being corroded or are suitably protected against being so corroded.

- Checks to electrical devices

Repair and maintenance to electrical components shall include initial safety checks and component inspection procedures. If a fault exists that could compromise safety, then no electrical supply shall be connected to the circuit until it is satisfactorily dealt with. If the fault cannot be corrected immediately but it is necessary to continue operation, an adequate temporary solution shall be used.

This shall be reported to the owner of the equipment so all parties are advised.

Initial safety checks shall include:

- 1) That capacitors are discharged: this shall be done in a safe manner to avoid possibility of sparking.
- 2) That no live electrical components and wiring are exposed while charging, recovering or purging the system.
- 3) That there is continuity of earth bonding.

Repairs to Sealed Components

- 1) During repairs to sealed components, all electrical supplies shall be disconnected from the equipment being worked upon prior to any removal of sealed covers, etc. If it is absolutely necessary to have an electrical supply to equipment during servicing, then a permanently operating form of leak detection shall be located at the most critical point to warn of a potentially hazardous situation.
- 2) Particular attention shall be paid to the following to ensure that by working on electrical components, the casing is not altered in such a way that the level of protection is affected. This shall include damage to cables, excessive number of connections, terminals not made to original specifications, damage to seals, incorrect fitting of glands, etc.

Ensure that apparatus is mounted securely.

Ensure that seals or sealing materials have not degraded such that they no longer serve the purpose of preventing the ingress of flammable atmospheres.

Replacement parts shall be in accordance with the manufacturer's specifications.

NOTES

The use of silicon sealant may inhibit the effectiveness of some types of leak detection equipment. Intrinsically safe components do not have to be isolated prior to working on them.

Repair to Intrinsically Safe Components

Do not apply any permanent inductive or capacitance loads to the circuit without ensuring that this will not exceed the permissible voltage and current permitted for the equipment in use.

Intrinsically safe components are the only types that can be worked on while live in the presence of a flammable atmosphere. The test apparatus shall be at the correct rating.

Replace components only with parts specified by the manufacturer. Other parts may result in the ignition of refrigerant in the atmosphere from a leak.

Cabling

Check that cabling will not be subject to wear, corrosion, excessive pressure, vibration, sharp edges or any other adverse environmental effects. The check shall also take into account the effects of ageing or continual vibration from sources such as compressors or fans.

Detection of Flammable Refrigerants

Under no circumstances shall potential sources of ignition be used in the searching for or detection of refrigerant leaks. A halide torch (or any other detector using a naked flame) shall not be used.

Removal and Evacuation

When breaking into the refrigerant circuit to make repairs or for any other purpose, conventional procedures shall be used. However, it is important that best practice is followed since flammability is a consideration. The following procedure shall be adhered to:

- 1) Remove refrigerant.
- 2) Purge the circuit with inert gas.
- 3) Evacuate.
- 4) Purge again with inert gas.
- 5) Open the circuit by cutting or brazing.

The refrigerant charge shall be recovered into the correct recovery cylinders.

The system shall be "flushed" with OFN to render the unit safe. This process may need to be repeated several times. Compressed air or oxygen shall not be used for this task.

Flushing shall be achieved by breaking the vacuum in the system with OFN and continuing to fill until the working pressure is achieved, then venting to atmosphere, and finally pulling down to a vacuum.

This process shall be repeated until no refrigerant is within the system. When the final OFN charge is used, the system shall be vented down to atmospheric pressure to enable work to take place.

This operation is absolutely vital if brazing operations on the pipework are to take place.

Ensure that the outlet for the vacuum pump is not close to any ignition sources and there is ventilation available.

Charging Procedures

In addition to conventional charging procedures, the following requirements shall be followed.

- 1) Ensure that contamination of different refrigerants does not occur when using charging equipment.
Hoses or lines shall be as short as possible to minimize the amount of refrigerant contained in them.
- 2) Cylinders shall be kept upright.
- 3) Ensure that the refrigeration system is earthed prior to charging the system with refrigerant.
- 4) Label the system when charging is complete (if not already).
- 5) Extreme care shall be taken not to overfill the refrigeration system.
- 6) Prior to recharging the system it shall be pressure tested with OFN. The system shall be leak tested on completion of charging but prior to commissioning. A follow up leak test shall be carried out prior to leaving the site.

Decommissioning

Before carrying out this procedure, it is essential that the technician is completely familiar with the equipment and all its detail. It is recommended good practice that all refrigerants are recovered safely. Prior to the task being carried out, an oil and refrigerant sample shall be taken in case analysis is required prior to reuse of reclaimed refrigerant. It is essential that electrical power is available before the task is commenced:

- 1) Become familiar with the equipment and its operation.
- 2) Isolate system electrically.
- 3) Before attempting the procedure ensure that:
 - Mechanical handling equipment is available, if required, for handling refrigerant cylinders.
 - All personal protective equipment is available and being used correctly.
 - The recovery process is supervised at all times by a competent person.
 - Recovery equipment and cylinders conform to the appropriate standards.
- 4) Pump down refrigerant system, if possible.
- 5) If a vacuum is not possible, make a manifold so that refrigerant can be removed from various parts of the system.
- 6) Make sure that cylinder is situated on the scales before recovery takes place.
- 7) Start the recovery machine and operate in accordance with manufacturer's instructions.
- 8) Do not overfill cylinders. (No more than 80 % volume liquid charge).
- 9) Do not exceed the maximum working pressure of the cylinder, even temporarily.
- 10) When the cylinders have been filled correctly and the process completed, make sure that the cylinders and the equipment are removed from site promptly and all isolation valves on the equipment are closed off.

11) Recovered refrigerant shall not be charged into another refrigeration system unless it has been cleaned and checked.

Labelling

Equipment shall be labelled stating that it has been de-commissioned and emptied of refrigerant. The label shall be dated and signed. Ensure that there are labels on the equipment stating the equipment contains flammable refrigerant.

Recovery

When removing refrigerant from a system, either for servicing or decommissioning, it is recommended good practice that all refrigerants are removed safely.

When transferring refrigerant into cylinders, ensure that only appropriate refrigerant recovery cylinders are employed. Ensure that the correct number of cylinders for holding the total system charge are available. All cylinders to be used are designated for the recovered refrigerant and labelled for that refrigerant (i. e. special cylinders for the recovery of refrigerant).

Cylinders shall be complete with pressure relief valve and associated shut-off valves in good working order. Empty recovery cylinders are evacuated and, if possible, cooled before recovery occurs.

The recovery equipment shall be in good working order with a set of instructions concerning the equipment that is at hand and shall be suitable for the recovery of flammable refrigerants. In addition, set of calibrated weighing scales shall be available and in good working order. Hoses shall be complete with leak-free disconnect couplings and in good condition. Before using the recovery machine, check that it is in satisfactory working order, has been properly maintained and that any associated electrical components are sealed to prevent ignition in the event of a refrigerant release. Consult manufacturer if in doubt.

There covered refrigerant shall be returned to the refrigerant supplier in the correct recovery cylinder, and the relevant Waste Transfer Notice arranged. Do not mix refrigerants in recovery units and especially not in cylinders.

If compressors or compressor oils are to be removed, ensure that they have been evacuated to an acceptable level to make certain that flammable refrigerant does not remain within the lubricant. The evacuation process shall be carried out prior to returning the compressor to the suppliers. When oil is drained from a system, it shall be carried out safely.

After-sales Services

When your air conditioner can not run in order, please shut down the machine and cut off the power supply immediately. Then contact dealers.

Important Safety Information



⚠ CAUTION

Do not attempt to install this unit by yourself. This unit requires installation by qualified persons.

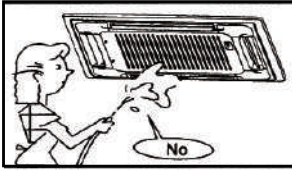

⚠ DANGER

Do not attempt to service the unit yourself. This unit has no user serviceable components. Opening or removing the cover will expose you to dangerous voltage. Turning off the power supply will not prevent potential electric shock.

⚠ DANGER

Never put hands or objects into the air outlet of indoor or outdoor units. These units are installed with a fan running at high speed. To touch the moving fan will cause serious injury.

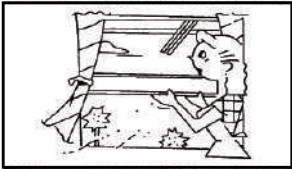

⚠ DANGER

To avoid the risk of serious electrical shock, Never sprinkle or spill water or liquids on unit.



⚠ WARNING

Ventilate the room regularly while the air conditioner is in use, especially if there is also a gas appliance in use in this room, Failure to follow these directions may result in a loss of oxygen in the room.

⚠ WARNING

To prevent electric shock, be sure to turn off the power before cleaning or maintenance.



⚠ WARNING

Do not use liquid cleaners or aerosol cleaners. use a soft and dry cloth for cleaning the unit. To avoid electric shock, never attempt to clean the units by sprinkling water.

⚠ CAUTION

Do not use caustic household drain cleaners in the unit. Drain cleaners can quickly destroy the unit components (drain pan and heat exchanger coil etc).



⚠ NOTE

For proper performance, operate the unit in temperature and humidity ranges indicated in this owner's manual. If the unit is operated beyond these conditions, it may cause malfunctions of the unit or dew dripping from the unit.

Troubleshooting

Error Code	Error Content	Error History Times	Error Definition and Protection
E0	Indoor and outdoor communication failure	1	Hardware Error
E1	Indoor room temperature sensor failure	2	Hardware Error
E2	Indoor pipe temperature sensor failure	3	Hardware Error
E3	Outdoor fancoil temperature sensor failure	4	Hardware Error
E4	Abnormal system malfunction (lack of refrigerant)	5	Hardware Error
E5	Model configuration error	6	Hardware Error
E6	Indoor PG/DC fan motor failure	7	Hardware Error
E7	Outdoor ambient temperature sensor failure	8	Hardware Error
E8	Outdoor exhaust temperature sensor failure	9	Hardware Error
E9	Outdoor IPM module failure/compressor drive failure	10	Hardware Error
EA	Outdoor current sensor failure	11	Hardware Error
Eb	The Main PCB and Display board communication abnormal	12	Hardware Error
EC	Outdoor modules Communication failure	13	Hardware Error
EE	Outdoor EEPROM fault	14	Hardware Error
EF	Outdoor DC fan motor failure	15	Hardware Error
EH	ODU Suction pipe temperature sensor failure	16	Hardware Error
EP	Outdoor compressor casing top failure	17	Hardware Error
EU	Outdoor voltage sensor failure	18	Hardware Error
Ej	Outdoor central coil temperature sensor failure	30	Hardware Error
En	Outdoor air pipe temperature sensor failure	31	Hardware Error
Ey	Outdoor liquid pipe temperature sensor failure	32	Hardware Error
P0	IPM module protection	19	Others Error
P1	Overvoltage and undervoltage protection	20	Others Error

Error Code	Error Content	Error History Times	Error Definition and Protection
P2	Overcurrent protection	21	Others Error
P3	Other protections	22	Others Error
P4	Protection against excessive outdoor exhaust temperature	23	Others Error
P5	Subcooling protection on Cooling mode	24	Others Error
P6	Overheating protection on Cooling mode	25	Others Error
P7	Overheating protection on Heating mode	26	Others Error
P8	Protection against high or low outdoor temperature	27	Remote control display adjustment
P9	Compressor drive protection (abnormal load)	28	Others Error
PA	Communication failure/mode conflic	29	Others Error
F0	Infrared human sensing sensor failure	33	Remote control display adjustment
F1	Battery module failure	34	Remote control display adjustment
F2	Exhaust temperature sensor failure protection	35	Others Error
F3	Failure protection of outer tube temperature sensor	36	Others Error
F4	Abnormal protection of refrigerant circulation	37	Others Error
F5	PFC protection	38	Others Error
F6	Compressor missing/reverse phase protection	39	Others Error
F7	Module temperature protection	40	Others Error
F8	Abnormal commutation of four-way valve	41	Others Error
F9	Module temperature sensor circuit malfunction	42	Hardware Error
FA	Compressor phase current detection fault	43	Hardware Error
Fb	Cooling and heating overload protection limit frequency reduction	44	Remote control display adjustment
FC	Limiting/Reducing frequency for High power consumption protection	45	Remote control display adjustment
FE	Module current (compressor phase current) protection limit/frequency reduction	46	Remote control display adjustment
FF	Module temperature protection limit/ frequency reduction	47	Remote control display adjustment

Error Code	Error Content	Error History Times	Error Definition and Protection
FH	Drive protection limit/frequency reduction	48	Remote control display adjustment
FP	Anti condensation protection limit/ frequency reduction	49	Remote control display adjustment
FU	Anti freezing protection limit/frequency reduction	50	Remote control display adjustment
Fj	Exhaust protection limit/frequency reduction	51	Remote control display adjustment
Fn	External AC current protection limit/ frequency reduction	52	Remote control display adjustment
Fy	Lack of gas protection	53	Others Error
H1	High pressure switch malfunction	54	Hardware Error
H2	Low pressure switch malfunction	55	Hardware Error
bf	TVOC sensor failure	56	Remote control display adjustment
bc	PM2.5 sensor failure	57	Remote control display adjustment
bj	Humidity sensor failure	58	Remote control display adjustment
bE	CO2 sensor malfunction	59	Hardware Error
bd	Fresh air module failure	60	Hardware Error
d4	Water full protection	61	Others Error
d5	Access control protection	62	Hardware Error
Fd	Refrigerant sensor fault	65	Hardware failure
Hd	Refrigerant leakage protection	66	Hardware failure

Disposal Guideline

- 1) Minimum installation height, minimum room area (operating or storage) refer to installation manual.
- 1) La taille minimale d'installation, la surface minimale de pièce (opération ou stockage) se réfèrent au manuel d'installation.
- 2) Risk Of Fire-Auxiliary devices which may be ignition sources shall not be installed in the ductwork, other than auxiliary devices listed for use with the specific appliance. See instructions.
- 2) Risque d'incendie - l'équipement auxiliaire qui peut être une source d'inflammation ne doit pas être installé dans le système de tuyauterie, à l'exception de l'équipement auxiliaire utilisé avec un équipement spécifique. voir les instructions.

-
- 3) Mount with the lowest moving parts at least 2.5m (8.2ft) above floor or grade level.
 - 3) Installé avec la partie mobile la plus basse au moins 2.5m(8.2ft) au-dessus du sol ou du plan du sol.
 - 4) Risk of electric shock. Can cause injury or death. Disconnect all remote electric power supplies before servicing.
 - 4) Risque de choc électrique. Causer des blessures ou la mort. Avant la réparation, débranchez toute alimentation à distance.
 - 5) Risk of Fire. Flammable Refrigerant Used. To Be Repaired Only By Trained Service Personnel. Do Not Puncture Refrigerant Tubing.
 - 5) Risque d'incendie. Utilisation de réfrigérants inflammables. L'entretien ne peut être effectué que par un personnel de maintenance formé. Ne pas percer la ligne de réfrigérant.
 - 6) Risk Of Fire. Dispose Of Properly In Accordance With Federal Or Local Regulations. Flammable Refrigerant Used.
 - 6) Risque d'incendie. Disposer correctement conformément à la réglementation fédérale ou locale. Utilisation de réfrigérants inflammables.
 - 7) Risk Of Fire. Flammable Refrigerant Used. Consult Repair Manual/Owner's Guide Before Attempting To Service This Product. All Safety Precautions Must Be Followed.
 - 7) Risque d'incendie. Utilisation de réfrigérants inflammables. Veuillez consulter le manuel de réparation/guide de l'utilisateur avant d'essayer de réparer ce produit. Toutes les précautions de sécurité doivent être respectées.
 - 8) Risk Of Fire. Due to Flammable Refrigerant Used. Follow Handling Instructions Carefully in Compliance with National Regulations.
 - 8) Risque d'incendie causé par l'utilisation de réfrigérants inflammables. Suivez attentivement les instructions de manutention conformément aux réglementations nationales.
 - 9) Warning: before accessing the terminals, all power supply circuits must be disconnected.
 - 9) Avertissement: Avant d'accéder aux bornes de raccordement, tous les circuits d'alimentation doivent être déconnectés.



WARRANTY

Limited Warranty provided by Comfortside, LLC. (hereby referred to as Comfortside) applies only to registered products installed by a licensed HVAC technician and covers specified products and parts, subject to the following details:

Product Registration: Products must be registered for Limited Warranty within 60 days of installation by licensed HVAC technician. Products can be registered at armbridge.us. Alternatively, the warranty registration card from the product User's Manual can be filled out and sent in as instructed.

Warranty Coverage: The warranty covers the parts of the products which may be defective due to the quality of the materials or workmanship, under normal use and proper maintenance. Warranty is provided only to the first original owner of the Product, where it is originally installed, and is not transferable to the subsequent owners.

Warranty Exclusions: Comfortside is not responsible for any warranty claim:

1. For equipment installed outside of the Continental US and Canada.
2. For equipment not installed according to manufacturer's guidelines.
3. For equipment which has been removed from the original site of installation and reinstalled at another location.
4. If registration information cannot be verified (i.e., invalid license number or wrong information provided).
5. Regarding damages or repairs arising as a result of a faulty installation, inappropriate application, or improper use.
6. Regarding damages or repairs arising from any external perils, out of Comfortside's control, acts of nature such as fires, storms, accidents, floods, broken or frozen water pipes, electrical surges, input power with under or overvoltage, lightning, or existence of corrosive substances nearby.
7. Regarding damages or repairs arising from use of non-compatible parts, third-party components, alterations, modifications, or improper applications.
8. Regarding improper service or poor maintenance of the equipment, such as cleaning of all air filters, heat exchangers, fans, and blowers, in addition to any necessary lubrication of internal components and maintenance of external accessories.
9. Regarding changes that can be considered cosmetic, including but not limited to small fin damages, scratches on the unit cover, etc.
10. Regarding resetting of power or the circuit breakers and replacement of other types of fuses, both internal and external.
11. Regarding any damage caused using dirty, recycled, or wrong type of refrigerants and lubricants.
12. Regarding damage due to moisture, air, dust, sand, dirt, etc., that have been allowed into the system.
13. Regarding damage caused by continuing use of the product after a malfunction has been noticed or indicated at the display module, through an error code.
14. Regarding damages or performance issues due to improper matching, product selection, under-sizing, over-sizing, improper installation, or misuse.
15. Regarding loss or replacement of refrigerant, lubricant, or oil.
16. Regarding labor or any costs associated with labor.

Warranty Begin Date: Warranty begins on the date of registration.

Warranty End Date: Products that have not been registered as instructed above are not covered under Warranty. The length of your Warranty depends on the specific model unit you have purchased. Information on Warranty length is available online, by visiting armbridge.us. As further explained below in detail, coverage is only for the original registered user who owns and resides in the dwelling or operates business in the property in which the product is installed.

WARRANTY

Remaining Warranty: Any part, component or product that is replaced under the terms of the Warranty, will be covered under the same Warranty for the duration in which the original Warranty for the product is applicable.

Warranty Procedure: Comfortside will furnish a new or refurbished part, without any charge for the part itself, for the replacement of any part that has been determined to have failed, by Comfortside at its sole discretion, due to defects in its materials or workmanship under standard use and proper maintenance. The payment of the shipping costs for the part will be the sole responsibility of the owner of the product. Comfortside reserves the right to ask the owner of the product to return the failed part before or after a replacement part is sent out. The product owner or technician should contact Comfortside Technical Support at (800) 977-0722, Monday to Friday from 9AM to 8PM Eastern Time, while the technician is on site, servicing the unit. The product may or may not display error codes. The technician should be on site while troubleshooting with the Comfortside Technical Support Agent so he or she can address symptoms observed, specific electrical and mechanical measurements, and other detailed information that may be required for proper diagnosis.

While technicians may refer to Comfortside's website or YouTube channel for helpful information, such as manuals and videos based on certain error codes, the technician will need to troubleshoot with the Technical Support Agent for Warranty purposes. Comfortside is not able to remotely diagnose a product and or offer remedies, without proper diagnosis results.

When contacting Technical Support, a licensed technician must be onsite, and the following information needs to be provided:

- The Serial Number of the unit.
- The product purchase invoice and an installation invoice from licensed HVAC technician.
- Case number (if applicable) provided during previous Technical Support call(s).
- Comfortside may ask for photos and/or other diagnostic information it deems necessary prior to processing the Warranty claim.

It should be noted that Comfortside Technical Support Agents troubleshoot on a case-by-case basis, following best practices and procedures to diagnose problems and solutions. Through this process, it is most efficient to diagnose one issue or error code at a time. It is possible that the first suggested solution may or may not solve one problem of multiple failures, in which case the Technician will continue through troubleshooting for remaining issues/error codes.

Labor cost, materials, and other costs: Any labor costs and/or the costs for the supplies or materials used or purchased in the field for the replacement of the defective part, remain the responsibility of the owner. No other costs involved in diagnosis, lodging, transportation, servicing, repair, replacement, installation, removal, shipping, etc., are to be covered under the Warranty.

Refrigerant: Any costs related to charging, recharging, adjustment, or removal of refrigerant, and the cost of the refrigerant itself, are not covered under any circumstances. All products go through vigorous quality

Comfortside does not cover any claims related to the lack of refrigerant in new products, discovered upon arrival, or during installation, as well as subsequent refrigerant loss occurring at any time afterward.

WARRANTY

This Warranty is not transferable. No person or entity is authorized to change the terms and conditions outlined in this Warranty agreement, in any respect, nor to create any additional obligations or liabilities for any party involved.

This warranty agreement supersedes all prior warranty agreements between the parties and constitutes the complete, final, and exclusive understanding of the parties with respect to the subject matter. All prior negotiations, representations, or promises, whether oral or written, of either party shall be deemed to have been merged herein.

If any part of this Warranty Agreement shall be invalidated for any reason, such part shall be deleted, and the remainder shall be unaffected and shall continue in full force and effect. This Warranty provides you certain legal rights and you may also have other rights, which vary from State to State. Therefore, some of these limitations or exclusions may not apply to you.

States with Express and Implied Warranties: Products in states with Express and Implied Warranties do not need to be registered for Comfortside Warranty. However, for Warranty support, installation invoice should be provided.

Pursuing legal remedies:

ARBITRATION CLAUSE. IMPORTANT. PLEASE REVIEW THIS ARBITRATION CLAUSE, AS IT AFFECTS YOUR LEGAL RIGHTS.

1. This arbitration clause affects your rights against Comfortside and any of its employees, agents, affiliates, successors, or assignees, all of whom together are referred to below as “we” or “us” for the simplicity of reference.
2. **ARBITRATION REQUIREMENT; EXCEPT AS STATED BELOW, ANY DISPUTE BETWEEN YOU AND ANY OF US SHALL BE DECIDED BY NEUTRAL AND BINDING ARBITRATION, RATHER THAN ANY COURT OR BY TRIAL BY JURY. ARBITRATION WILL BE HANDLED ONLY ON AN INDIVIDUAL BASIS AND ALL PARTIES EXPRESSLY WAIVE; ANY RIGHTS TO PARTICIPATE AS A CLASS REPRESENTATIVE OR CLASS MEMBER, ANY RIGHTS TO CLASS ARBITRATION OR ANY CONSOLIDATION OF INDIVIDUAL ARBITRATIONS. THE ARBITRATOR WILL BE A MEMBER OF THE AMERICAN ARBITRATION ORGANIZATION.** The meaning of “Dispute” has the broadest possible meaning allowable by law, including any controversy, claim or other dispute, relating to or arising from the purchase of the product, any of the warranties upon the product, or the condition of the product, as well as the determination of the application or the scope of the Arbitration Clause itself. Rights to appeal and discovery are also limited in arbitration based on the rules of the arbitration organizations.
3. **Governing Law:** Effect and procedures of arbitration will be governed by the Federal Arbitration Act (9 U.S.C. § et seq.) rather than any related state law. In case of any substantive warranty, your claims and rights under such substantive warranty will be governed by the applicable law of the state in which Product was purchased.
4. **Location of the Arbitration:** Unless otherwise provided under the applicable law, arbitration hearing will be conducted in the judicial district in Miami-Dade County, Florida.
5. **Costs of the Arbitration:** Unless otherwise provided under the applicable law, each party will be responsible for its own cost, payable to the arbitration organization, and the costs of their attorneys, experts or other fees.
6. **Survival and Enforceability of the Arbitration Clause:** This arbitration clause will survive the expiration or termination of this warranty agreement, indefinitely.



DE-COMMISSIONING,DISMANTLING&DISPOSAL

This product contains refrigerant under pressure, rotating parts, and electrical connections which may be a danger & cause injur. All work must only be carried out by competent persons using suitable protective clothing and safety precautions.



Read the Manual



Risk of Electric Shock

RoHS



Unit is Remotely controlled
& may start without warning



1. Isolate all sources of electrical supply to the unit including any control system supplies switched by the unit. Ensure that all points of electrical and gas isolation are secured in the OFF position. The supply cables and gas pipe work may then be disconnected and removed. For points of connection refer to unit installation instructions.
2. Remove all refrigerant from each system of the unit into a suitable container using a refrigerant reclaim or recovery unit. This refrigerant may then be reused, if appropriate, or returned to the manufacturer for disposal. Under no circumstances should refrigerant be vented to atmosphere Where appropriate, drain the refrigerant oil from each system into a suitable container and dispose of according to local laws and regulations governing disposal of oily wastes.
3. Packaged units can generally be removed in one piece after disconnection as above. Any fixing down bolts should be removed and then unit lifted from position using the points provided and equipment of adequate lifting capacity. Reference **MUST** be made to the unit installation instructions for unit weight and correct methods of lifting. Note that any residual or spilt refrigerant oil should be mopped up and disposed of as described above.
4. After removal from position the unit parts may be disposed of according to local laws and regulations.
5. Meaning of crossed Out wheeled dustbin: Do not dispose of electrical appliances as unsorted municipal waste, use separate collection facilities. Contact your local government for information regarding the collection systems available. If electrical appliances are disposed of in landfills or dumps, hazardous substances can leak into the groundwater and get into the food chain, damaging your health and well being. When replacing old appliances with new ones, the retailer is legally obligated to take back your old appliance for disposals at least free of charge.

Made in China





03182026

Made in China